

The Sun's Magnetic Atmosphere

Dana Longcope

Department of Physics

Montana State University

Imprint of the magnetic field on the atmosphere

Outline

- I. In what state is the magnetic field when it enters the atmosphere?
Twist / Current / Helicity
- II. How does its state affect the atmosphere?
Propagation of Twist / Current / Helicity
- III. What kind of atmosphere does it create?
Magnetic Flux / X-ray flux relation
- IV. How does this happen? Reconnection

I. How sunspots are born

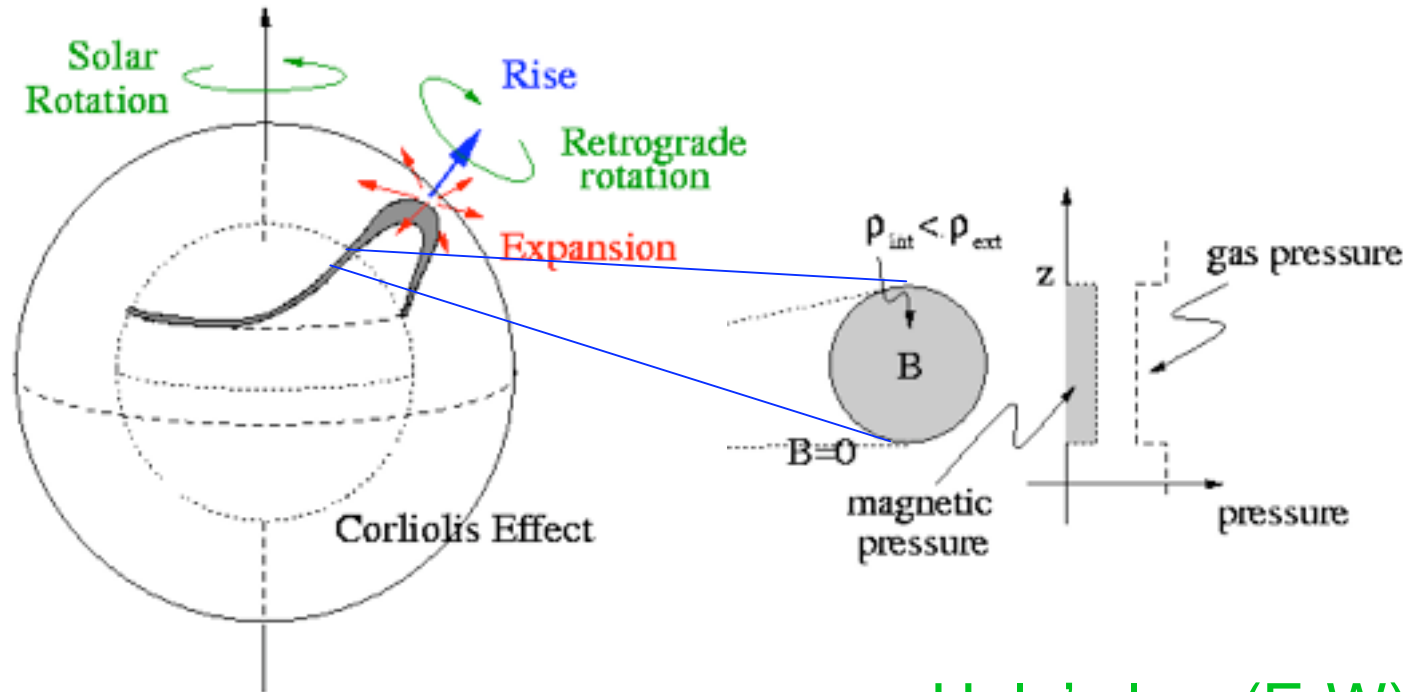

- generated in dynamo layer (tachocline)
- mostly toroidal (E-W)
- forms slender flux tubes
- emerge buoyantly through convection zone

- Hale's law (E-W)
- Joy's law (tilt)
- Proper motion after emergence

(Spruit 1981, Moreno-Insertis 1983, Choudhuri & Gilman 1987, Fan & Fisher 1995, Caligari et al. 1995...)

Emerging flux - simply

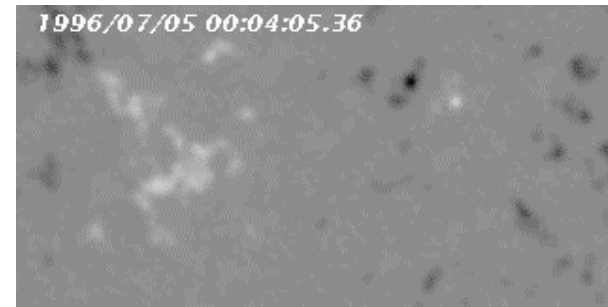
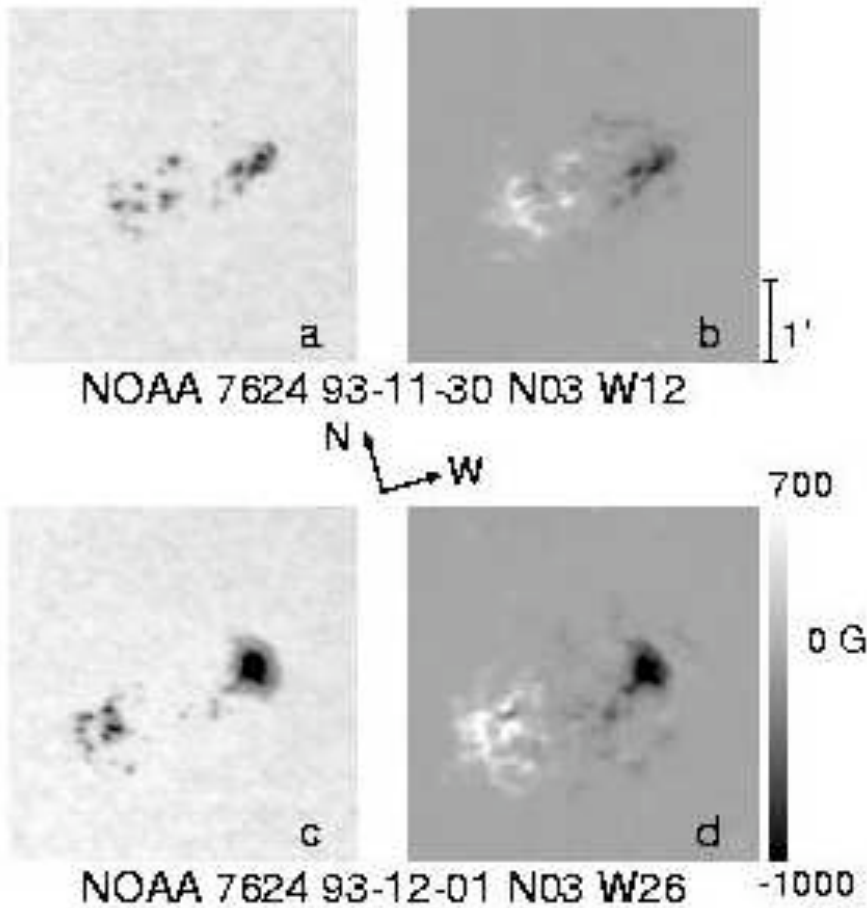

Interpretation: rising
flux tube

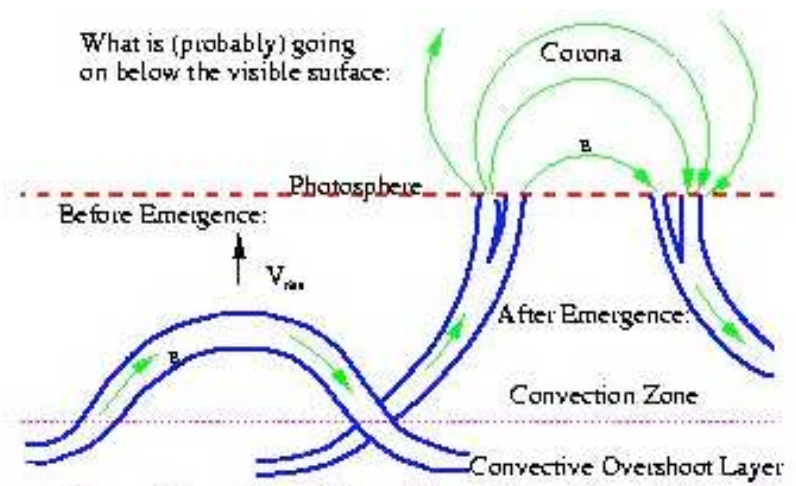

The importance of twist

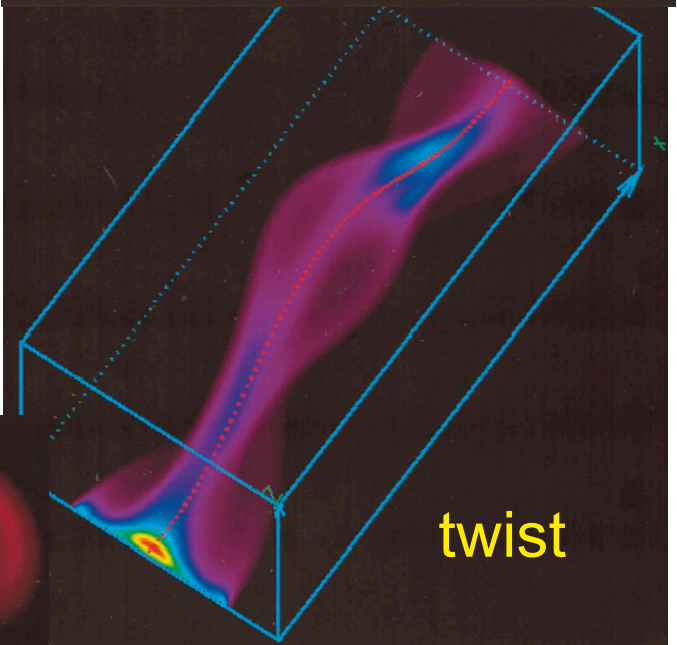
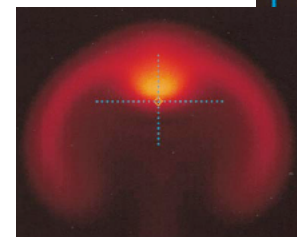
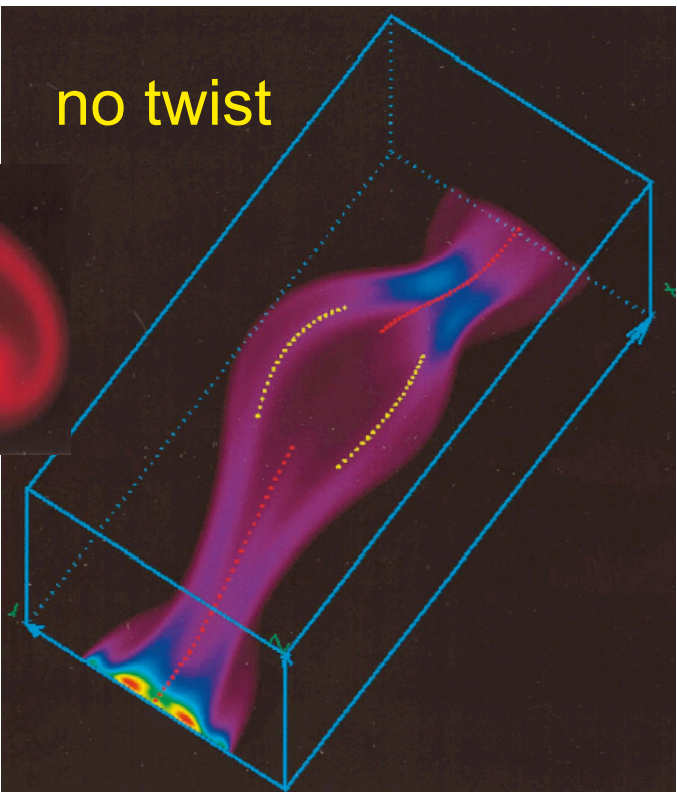
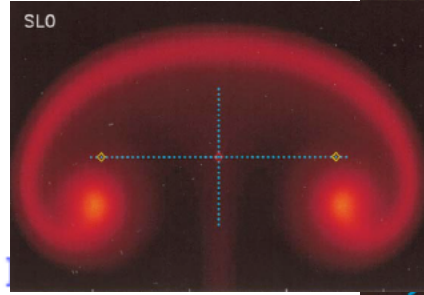
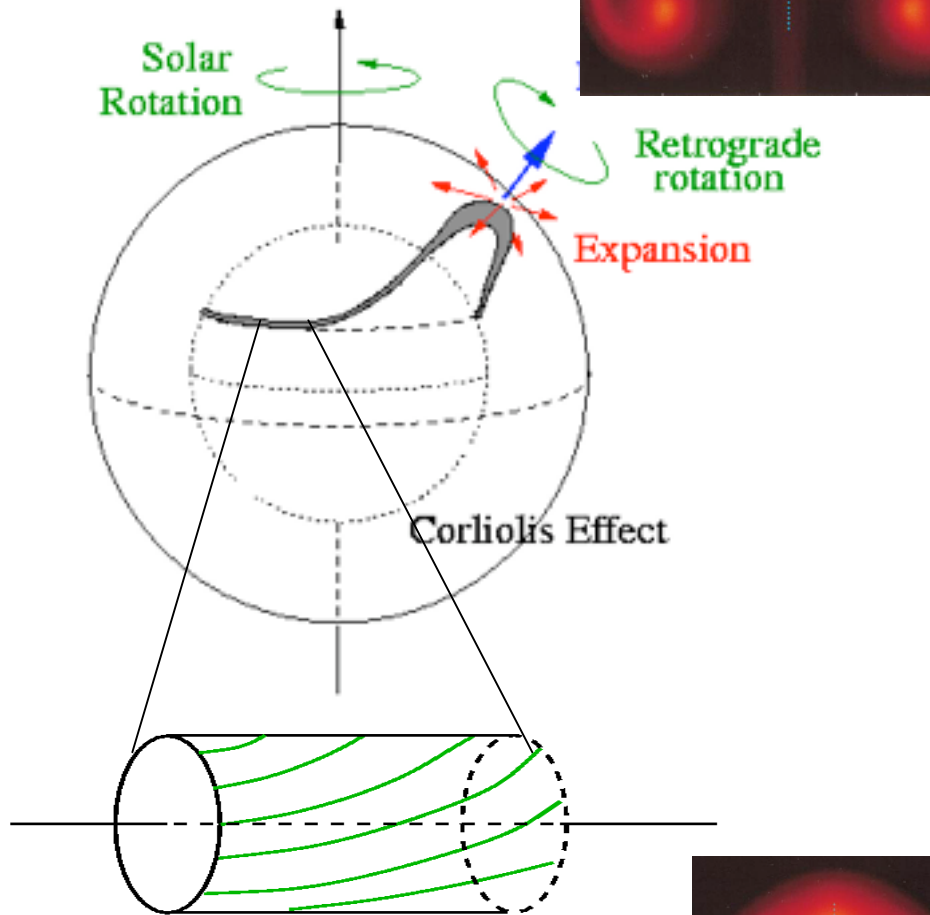

June 3, 2008

(Abbett Fisher & Fan, 2001)

$$\alpha_{\text{best}} < 0$$

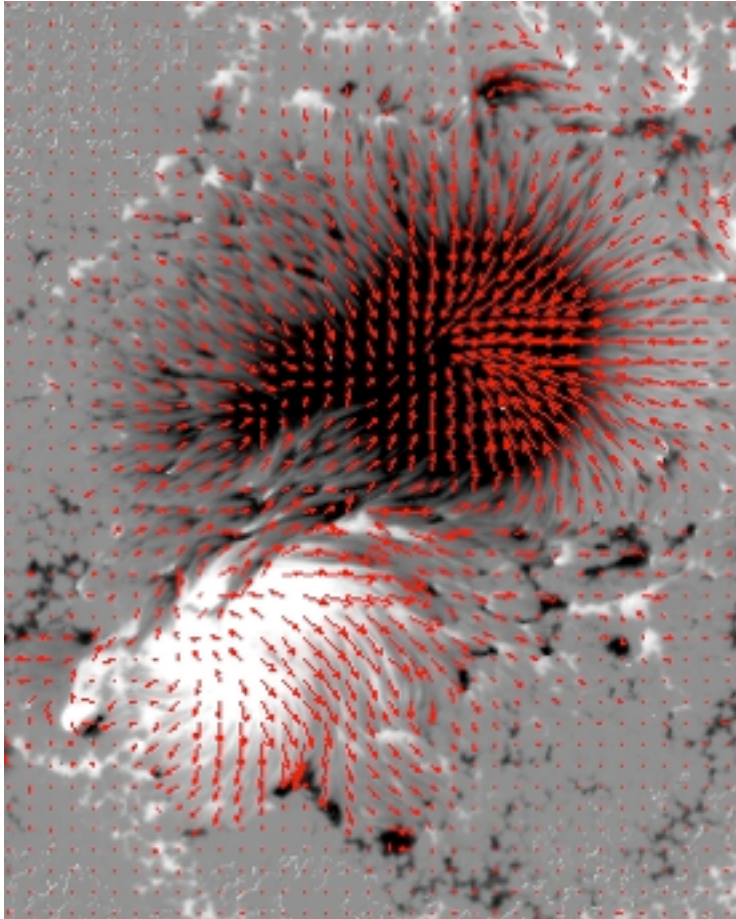

(courtesy Hinode)

$$\alpha = J_z / B_z$$

June 3, 2008

Twist in the magnetic field

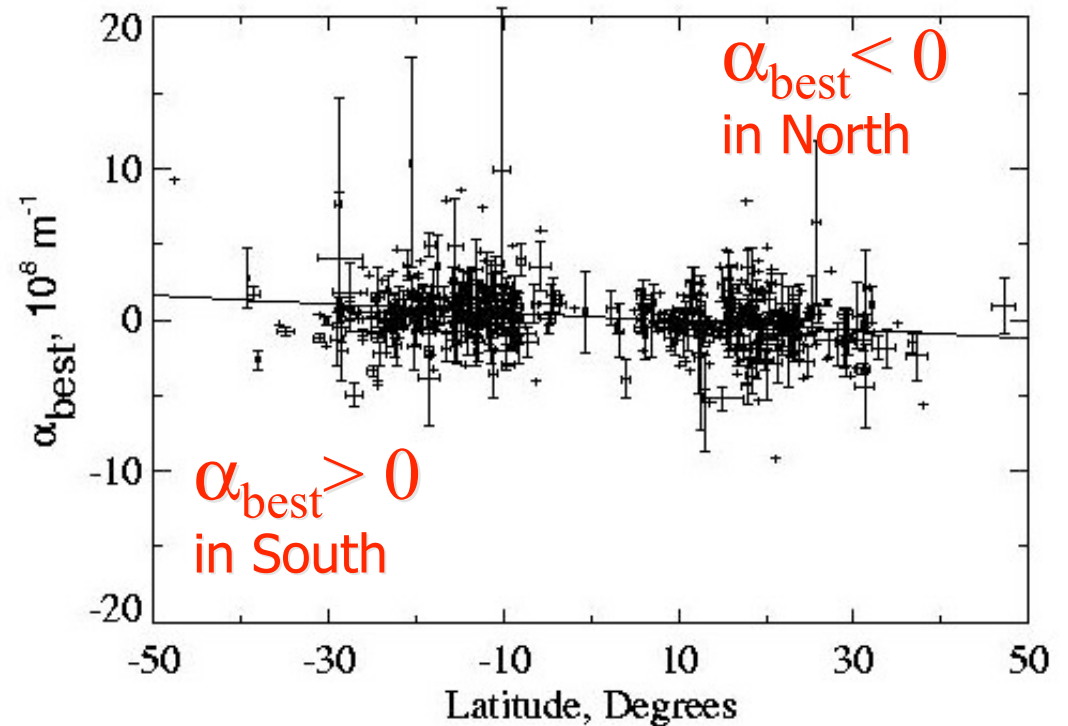

466 ARs from Longcope & Pevtsov 2003

Source of Twist

Left-handed deformation of axis

→ Right-handed twist (current)

Helicity Conservation

$$\frac{dT_w}{dt} = -\frac{dW_r}{dt}$$

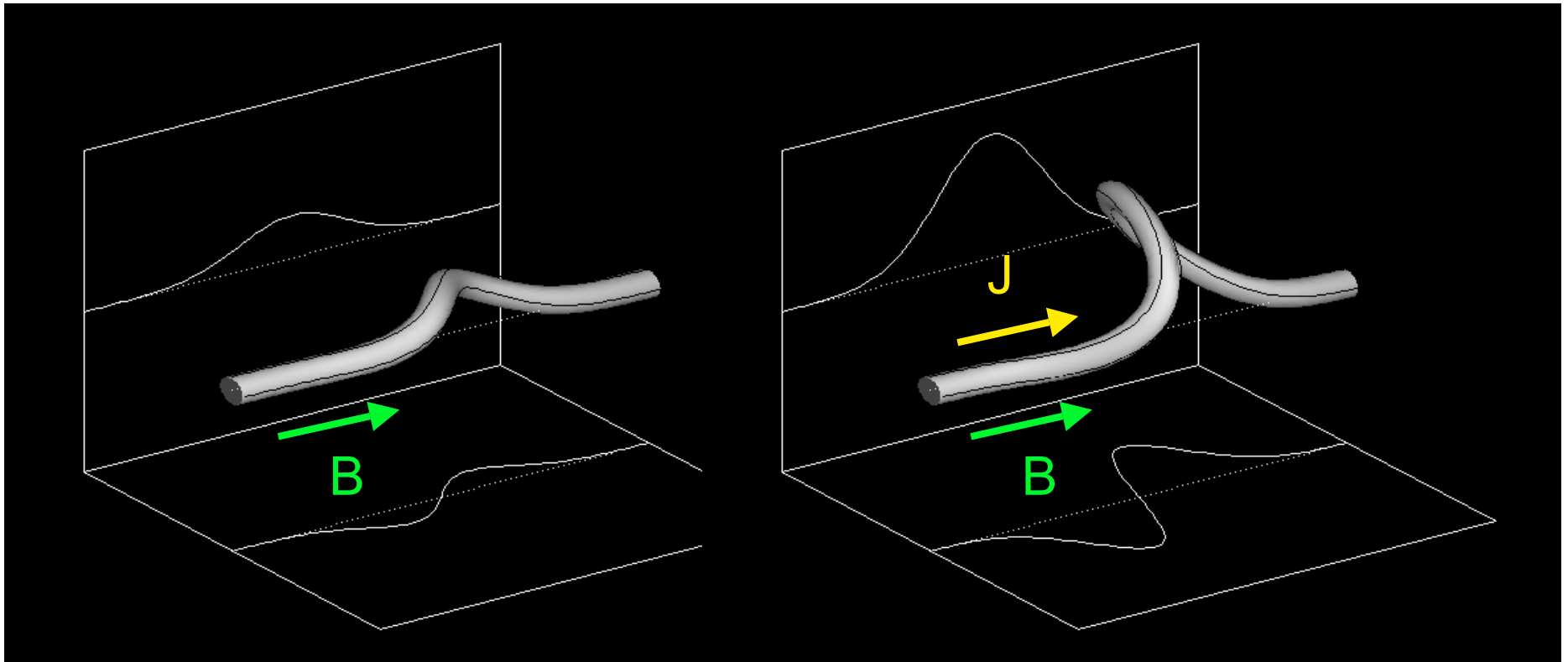

II. Emergence

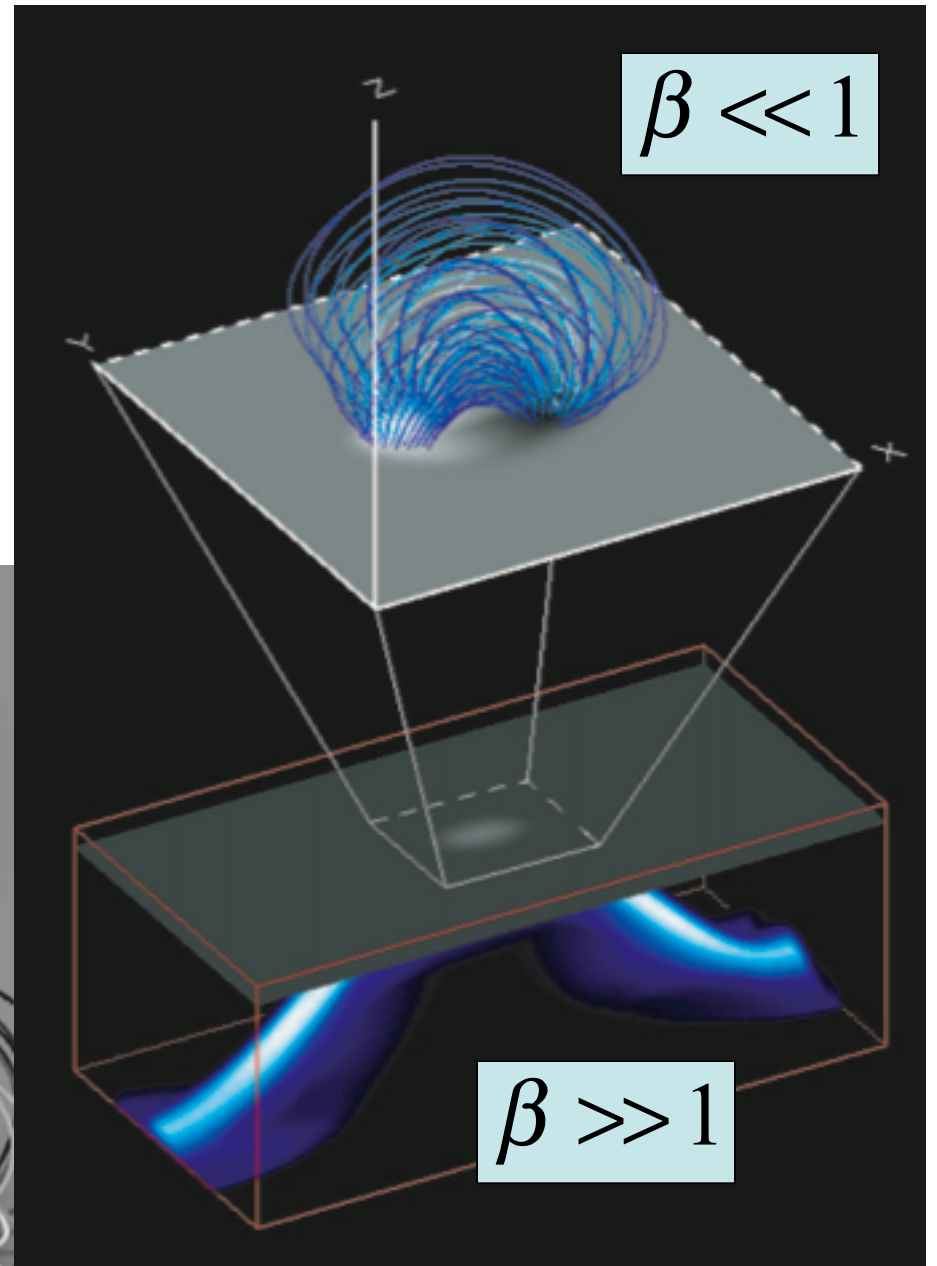
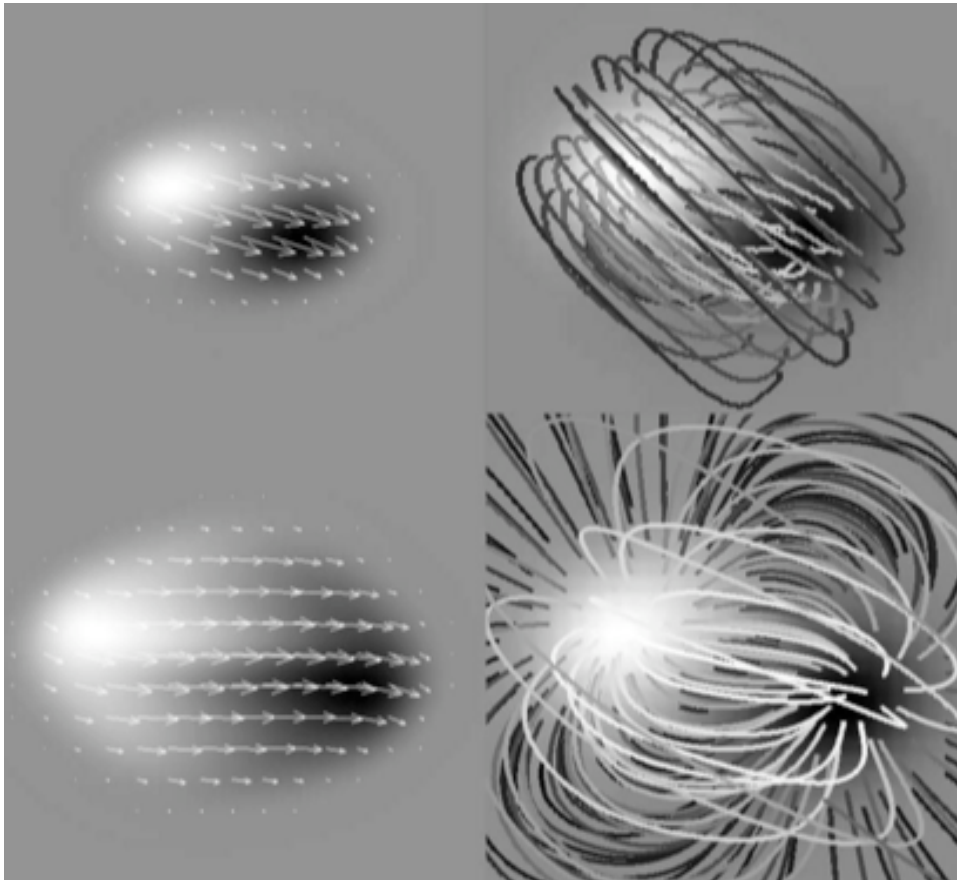

(Abbett & Fisher 2003)

Coupling flux tube to corona

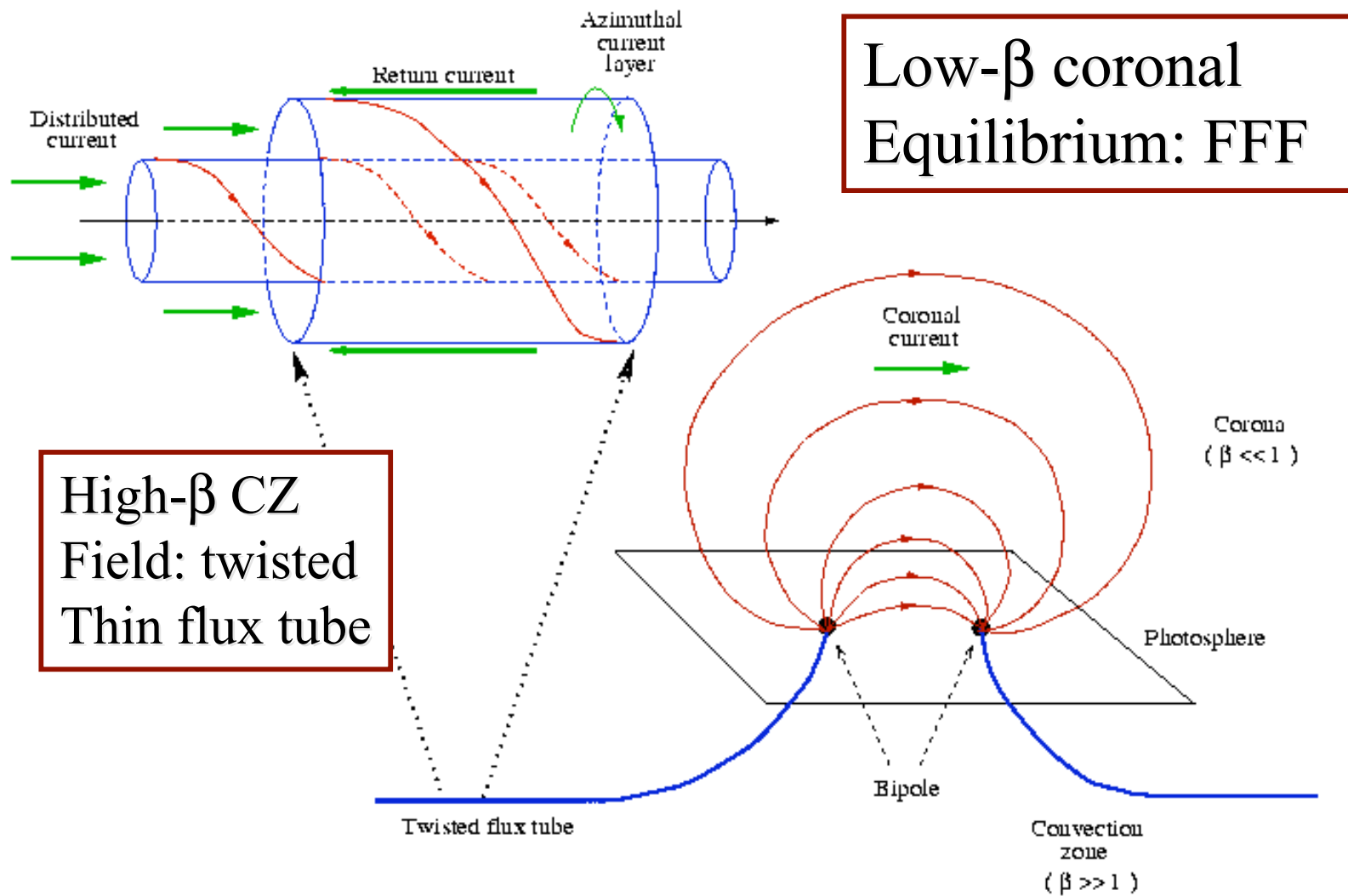

Coupling flux tube to corona

corona: $\beta \ll 1$
(force-free field)

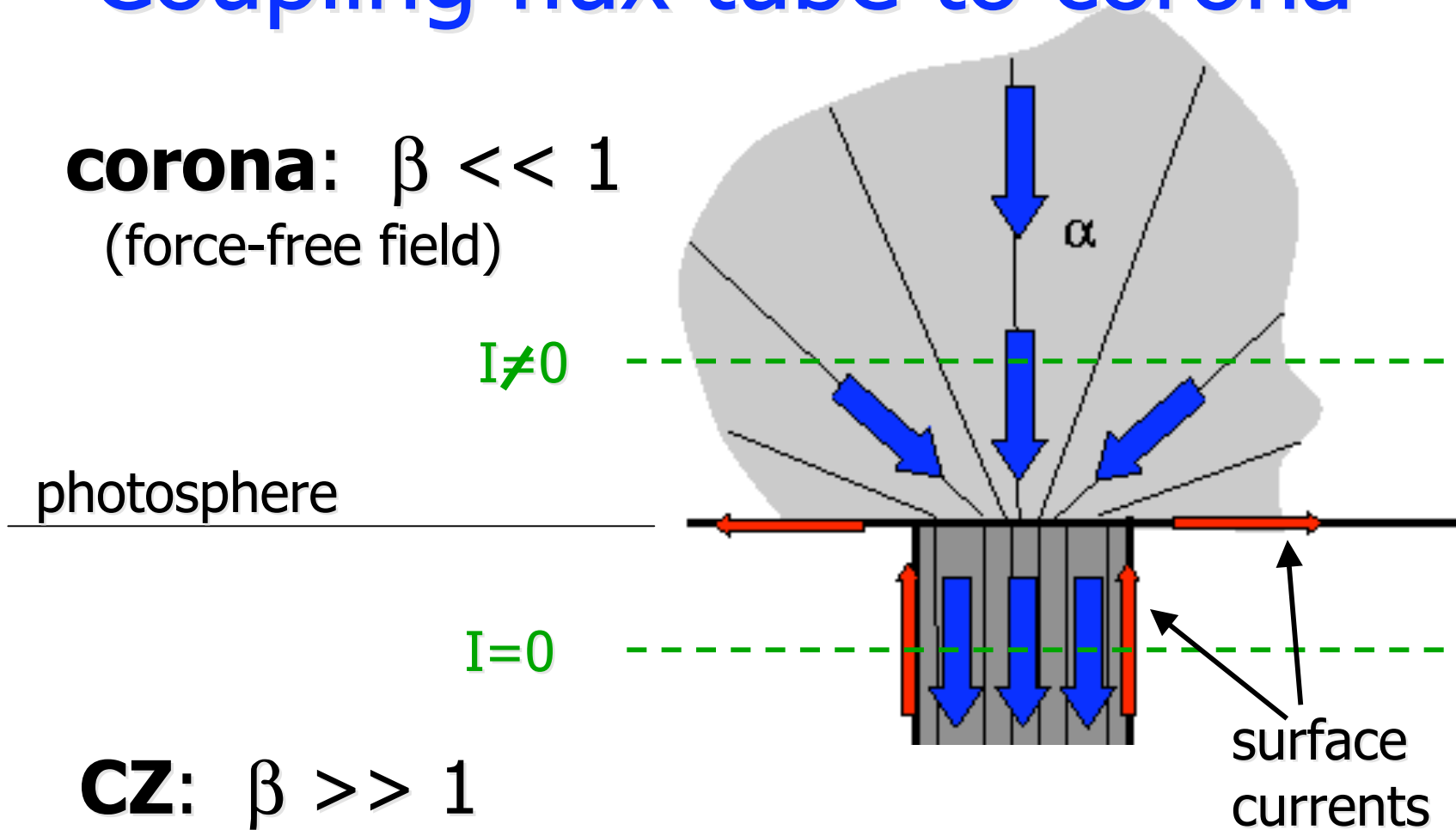

CZ: $\beta \gg 1$
(thin flux tube)

Coupling flux tube to corona

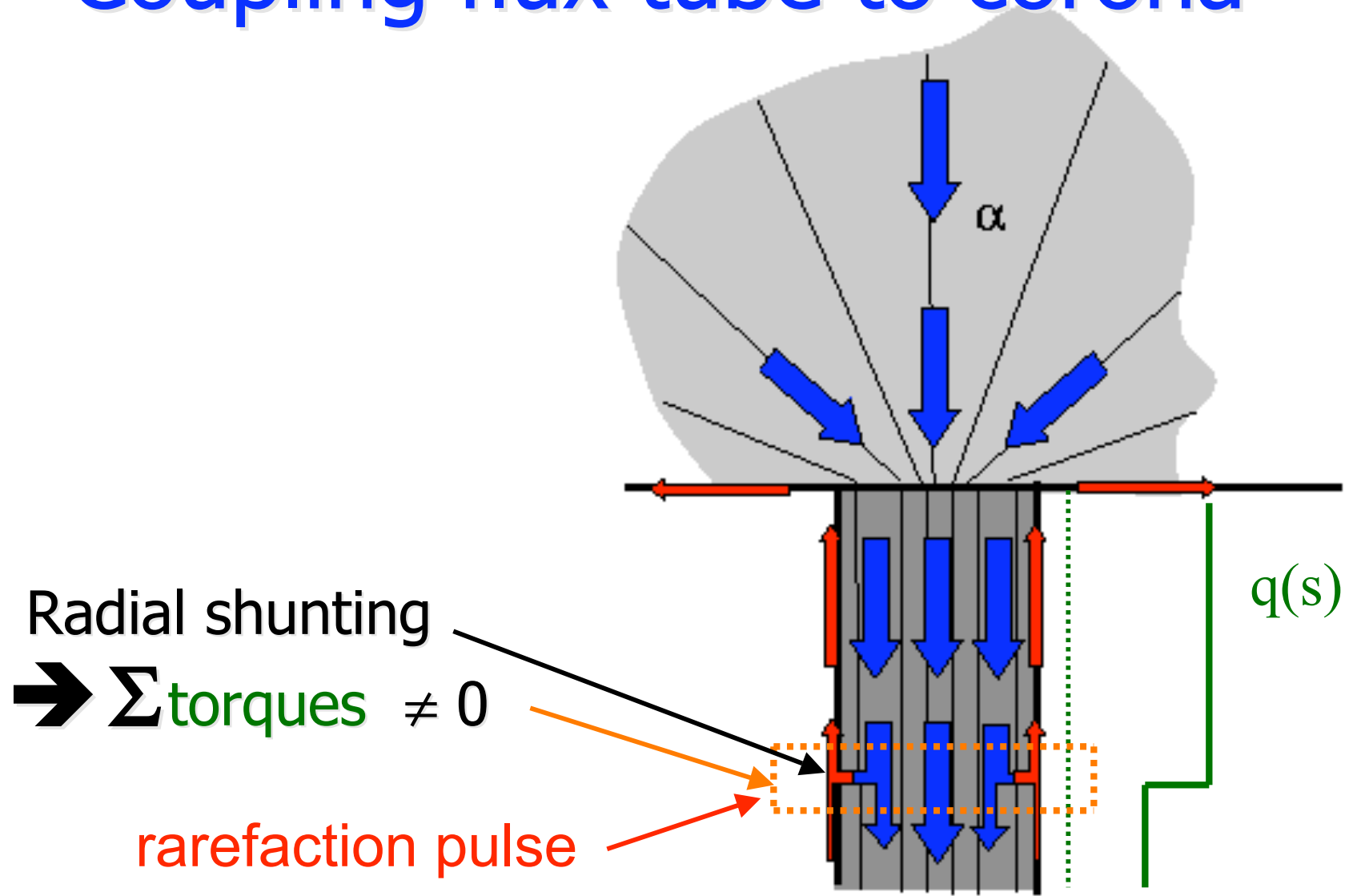

June 3, 2008

(Longcope & Wesloch 2000)₁₁

Observational Evidence

(Pevtsov, Maleev & Longcope 2003)

Fit Model to Data

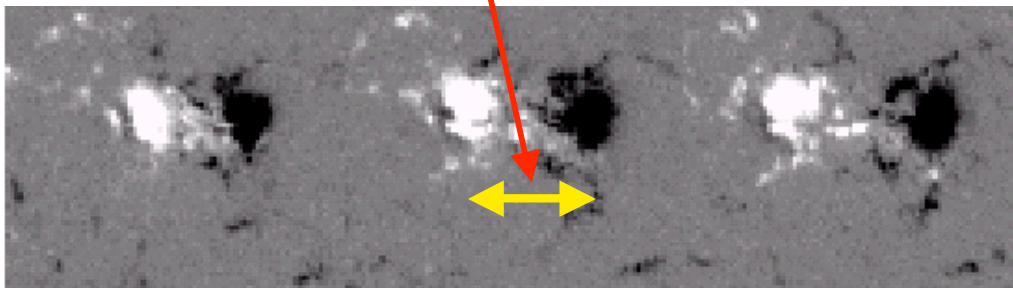
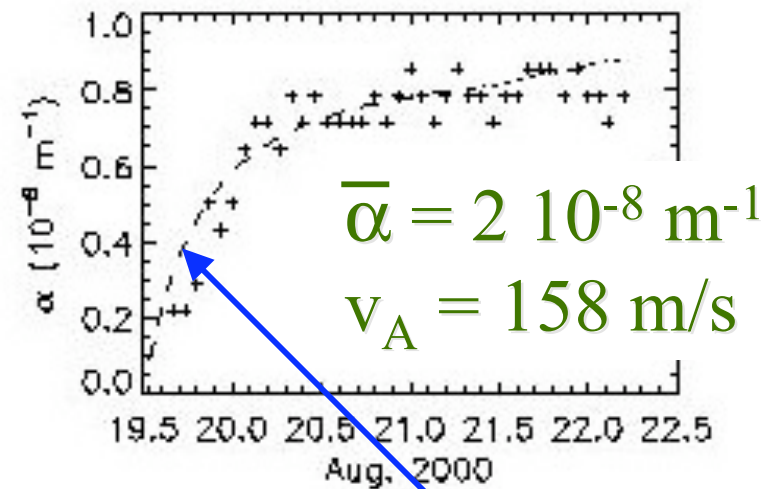
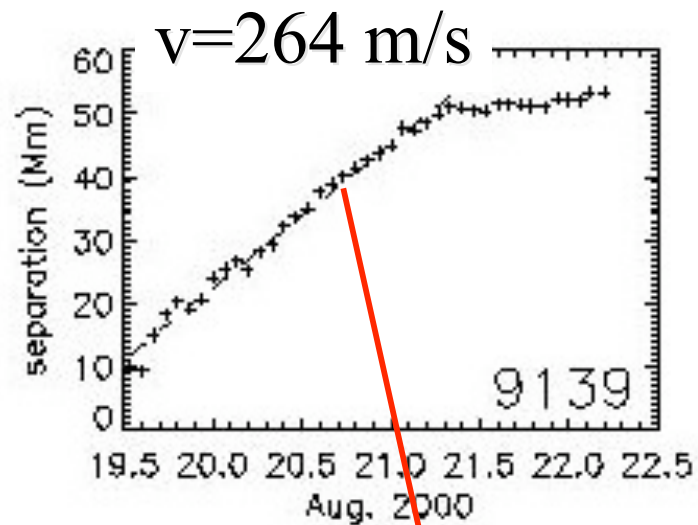

$$\alpha(t) = \bar{\alpha} \frac{v}{v+1} \left[1 - \left(\frac{d}{d_0} \right)^{-(v+1)} \right]$$

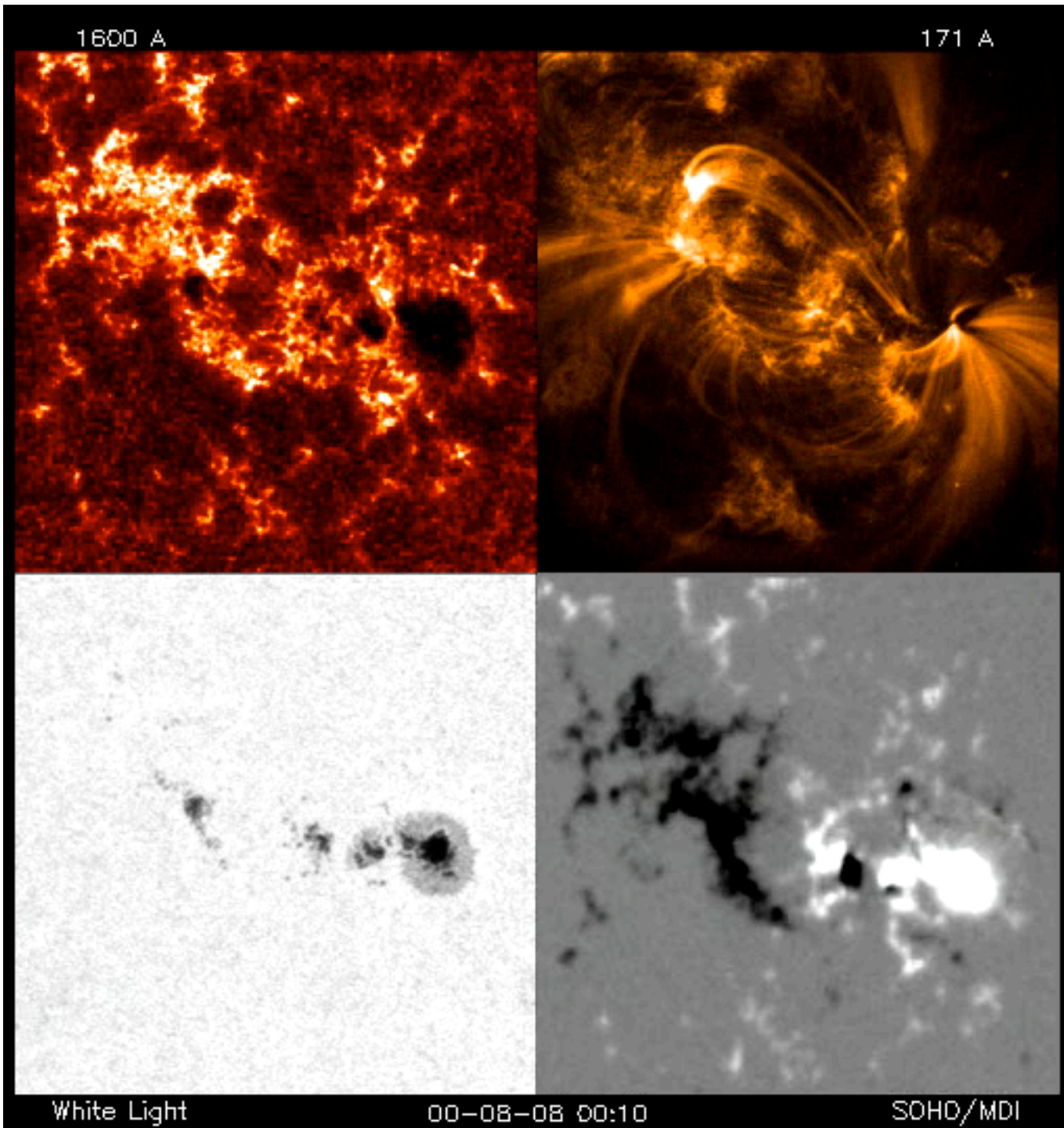

corona

photosphere

courtesy

D. Alexander

Net effect: helicity

$$H = \int_{\text{corona}} \mathbf{A} \cdot \mathbf{B} d^3x = \Phi^2 N_{\text{twist}}$$

$$\frac{dH}{dt} = - \frac{\Phi^2}{2\pi} \frac{d\theta}{dt}$$

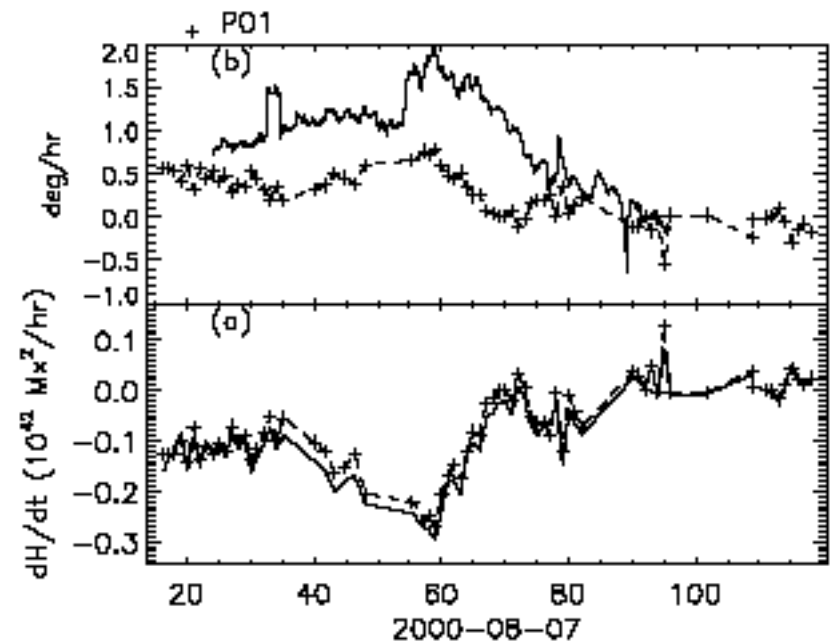
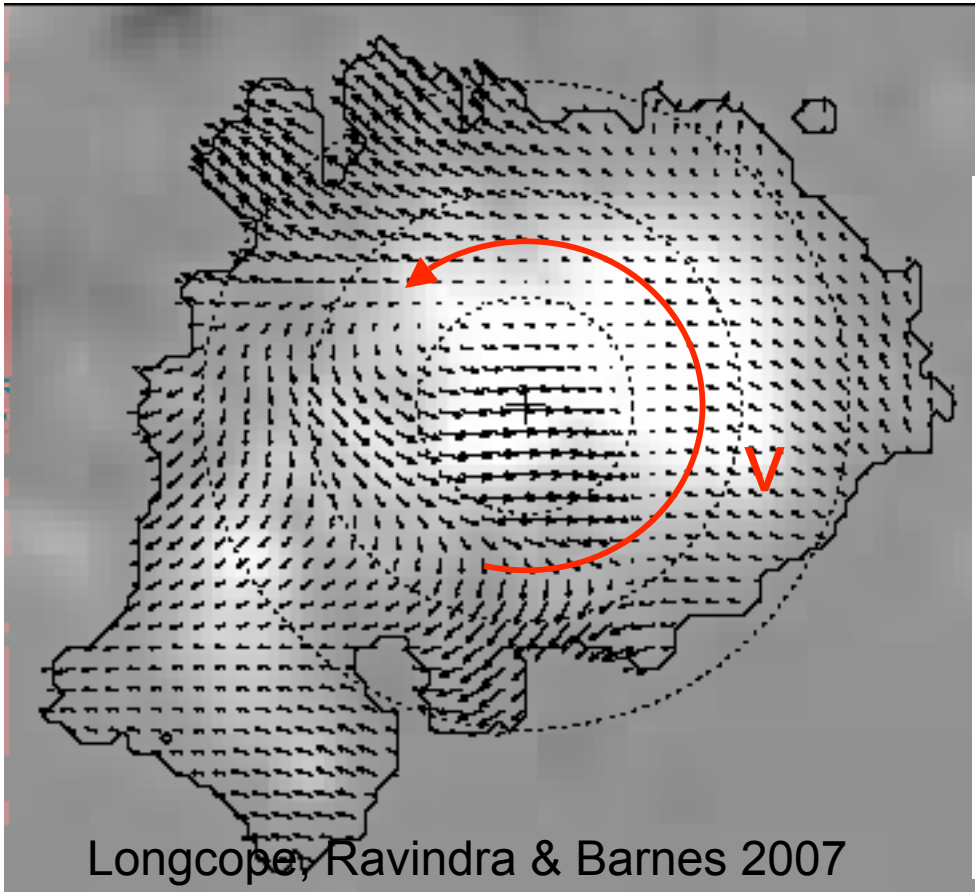

III. The corona

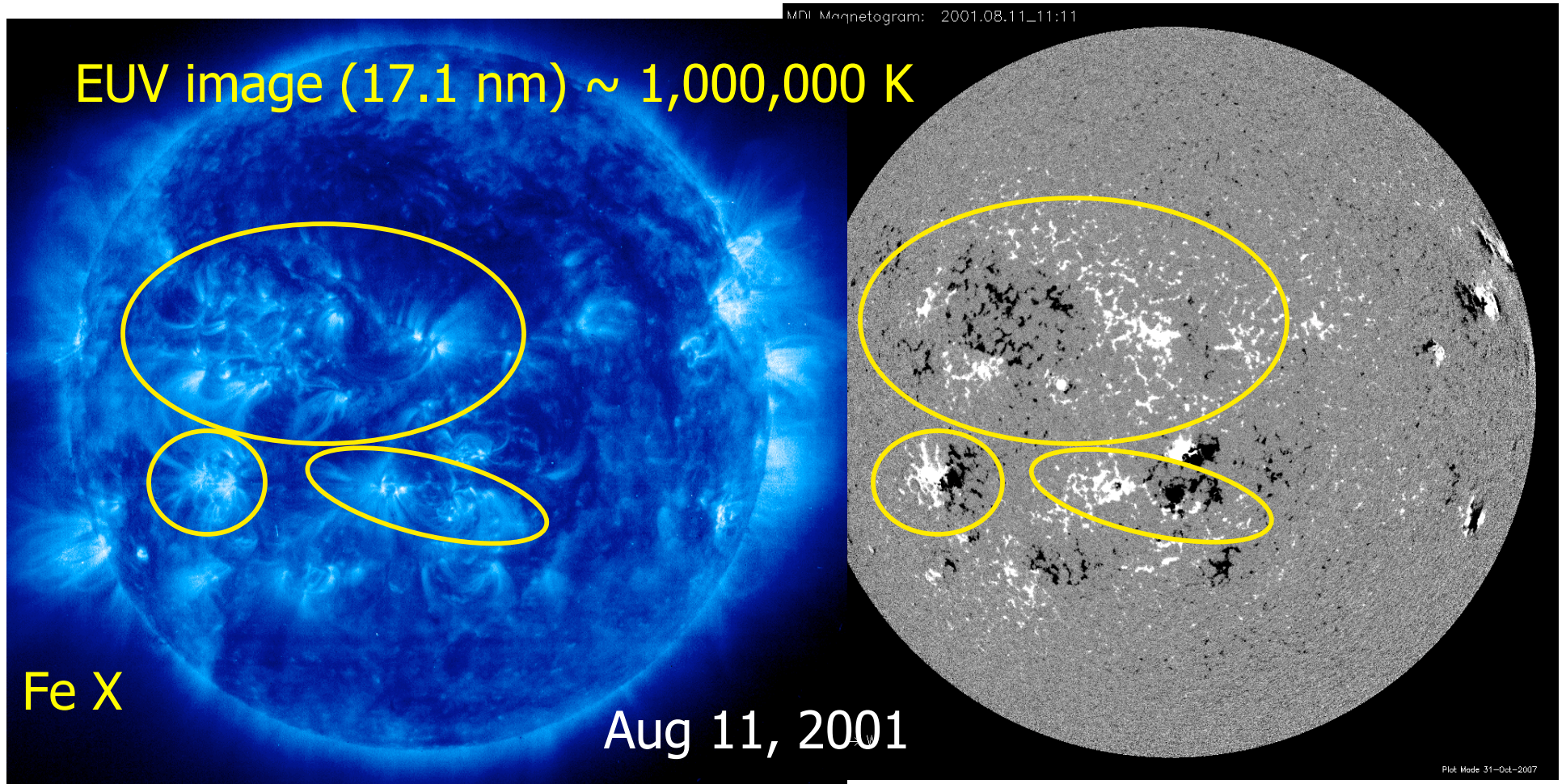

obvious suspect: magnetic field

X-ray bright points

Golub *et al.* 1977, Harvey 1985

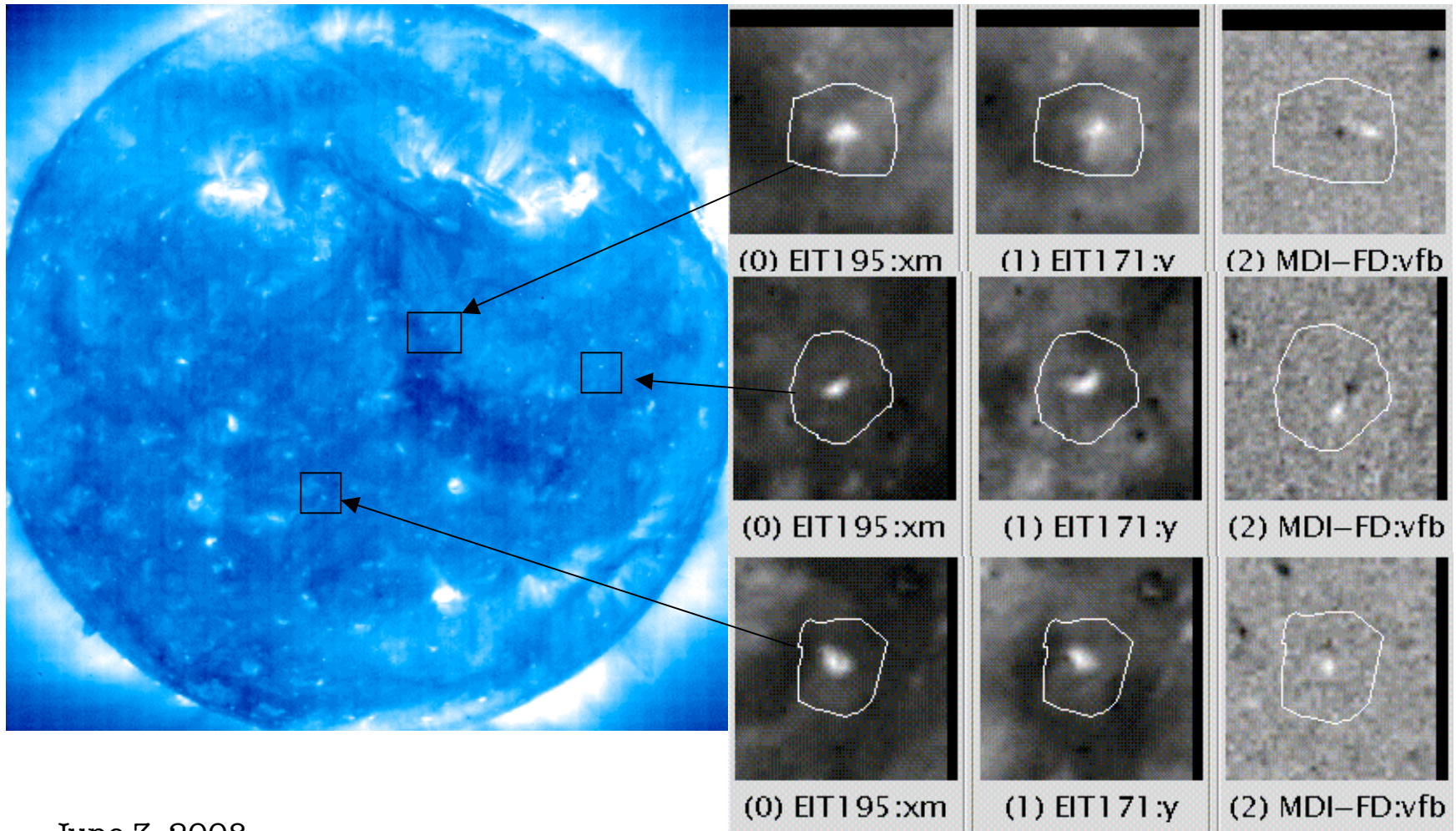

June 3, 2008

Magnetic features of all sizes

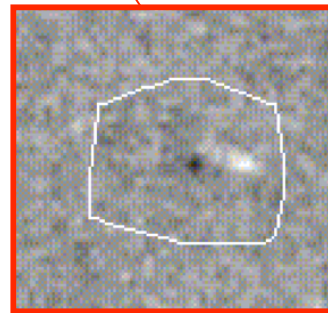
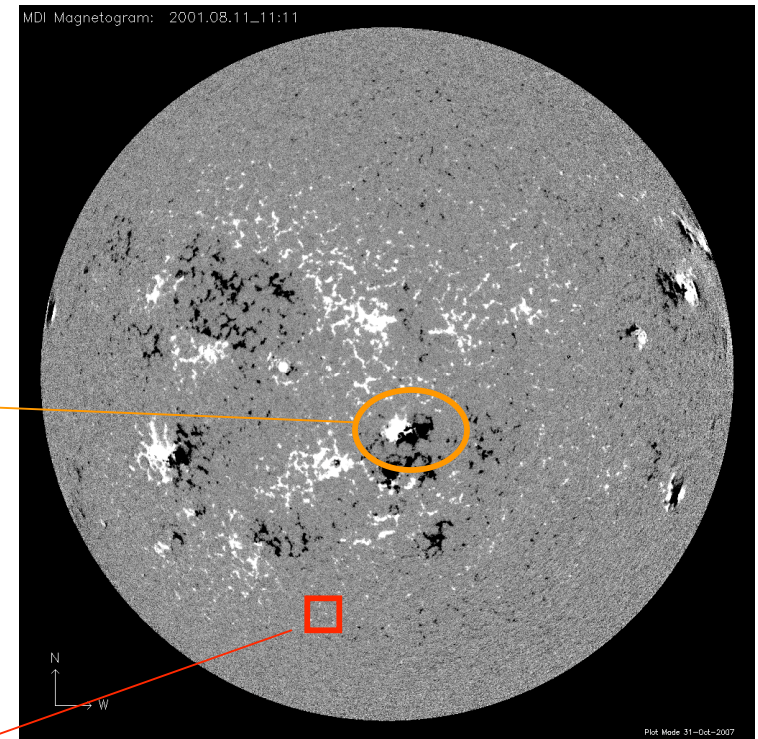
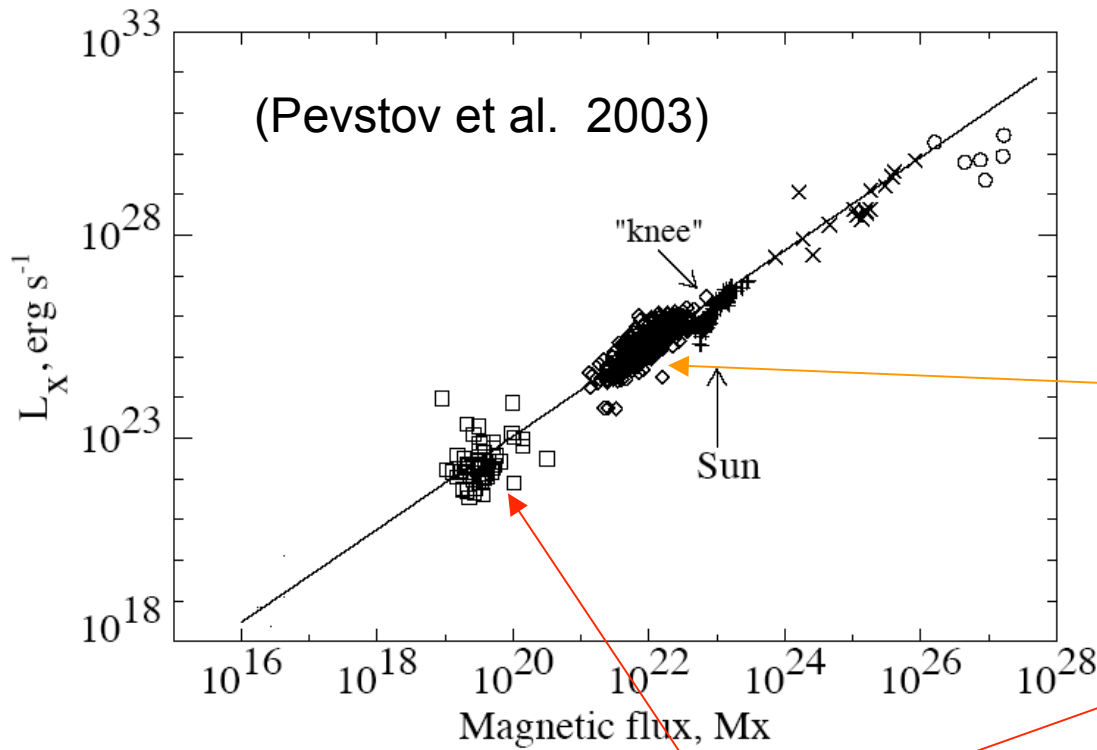

more magnetic flux
➔ more X-ray flux

June 3, 2008

17

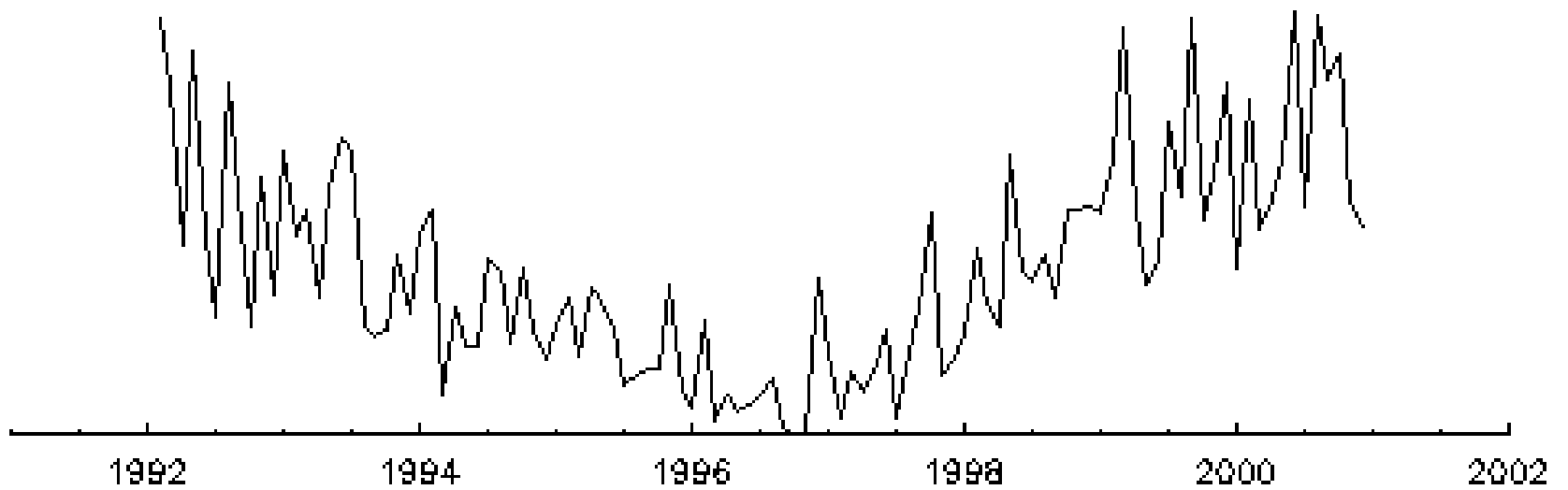
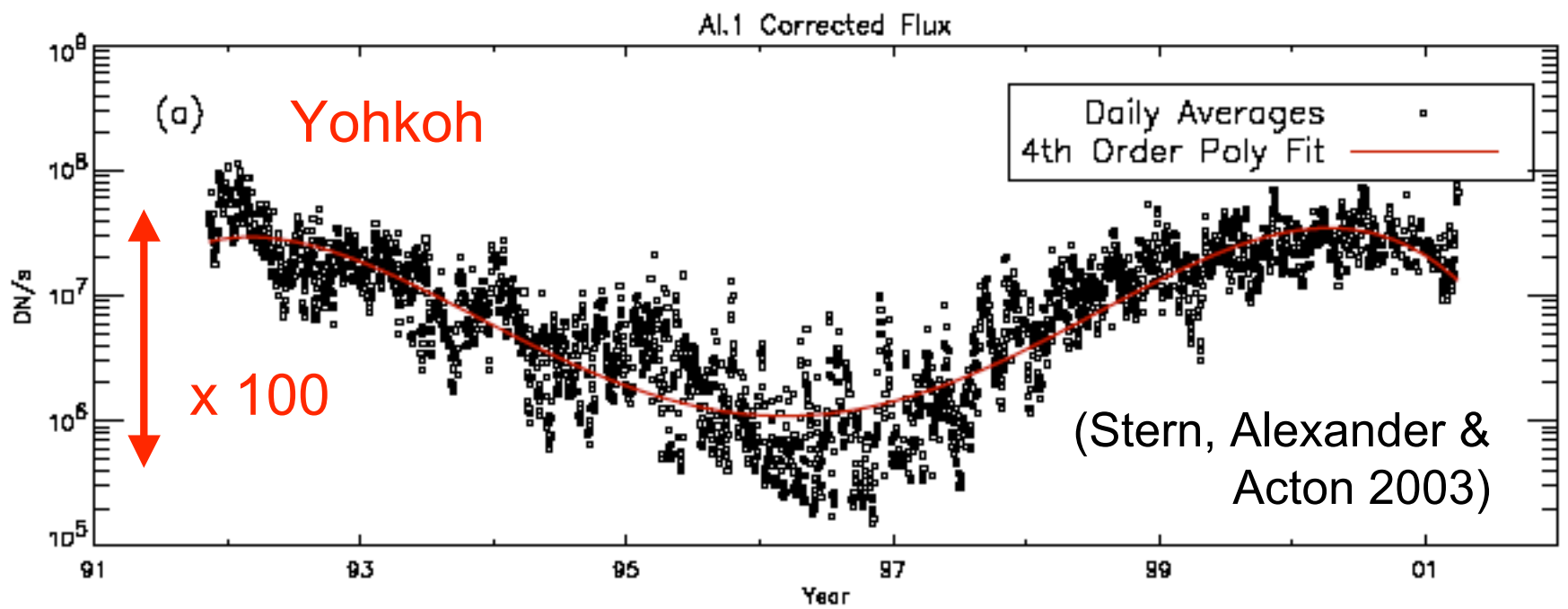

What does not explain it

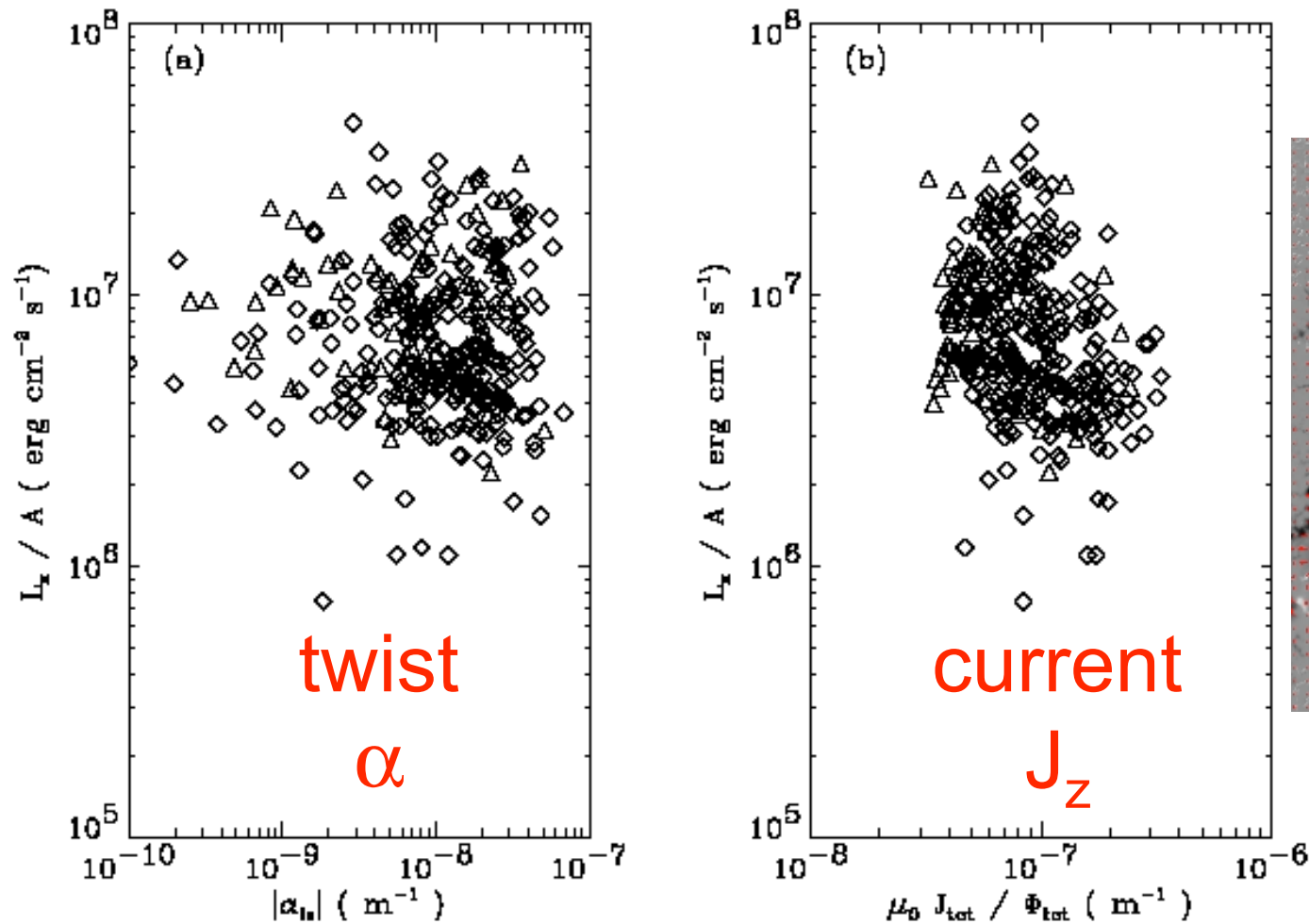

June 3, 2008

Fisher et al. 1998

19

What might: reconnection

Longcope & Kankelborg 1999

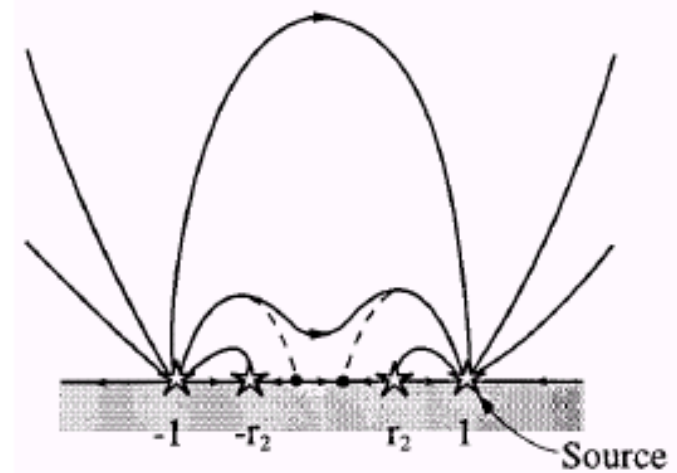
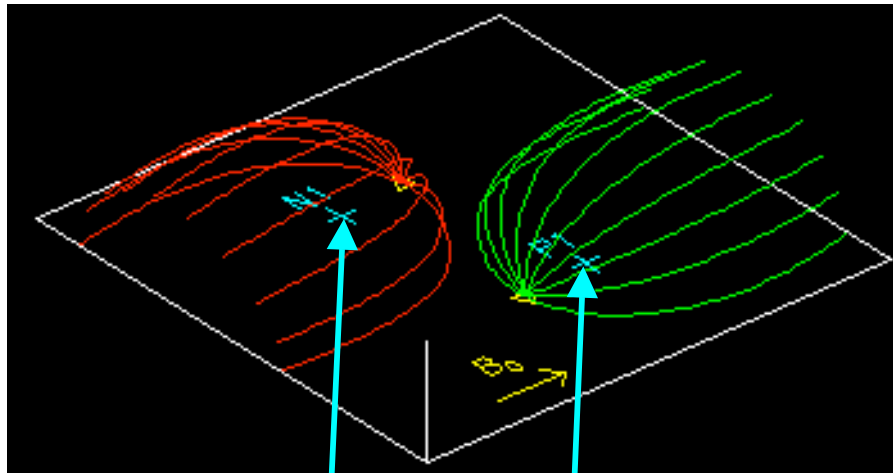

Photospheric flux
concentrations
sources of
coronal field

June 3, 2008

20

When 2 Poles Collide

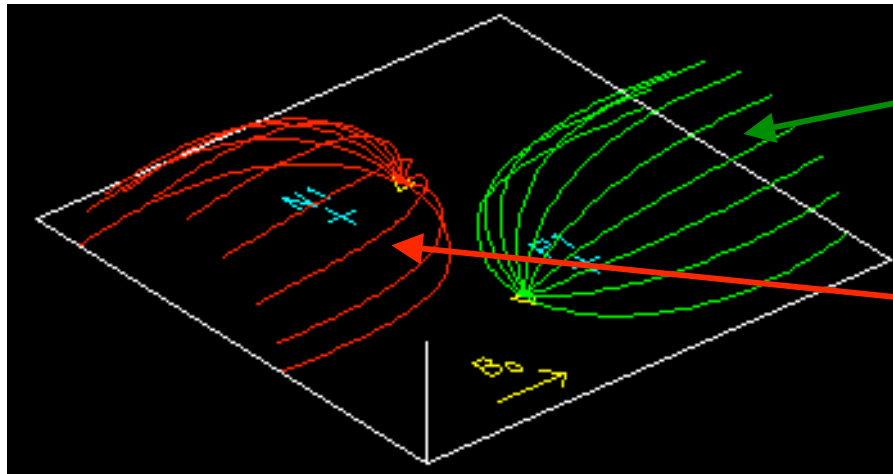

All field lines from
positive source P1

All field lines to
negative source N1

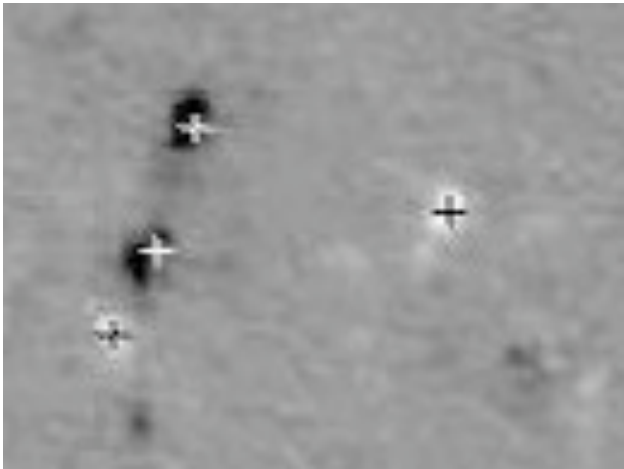

June 3, 2008

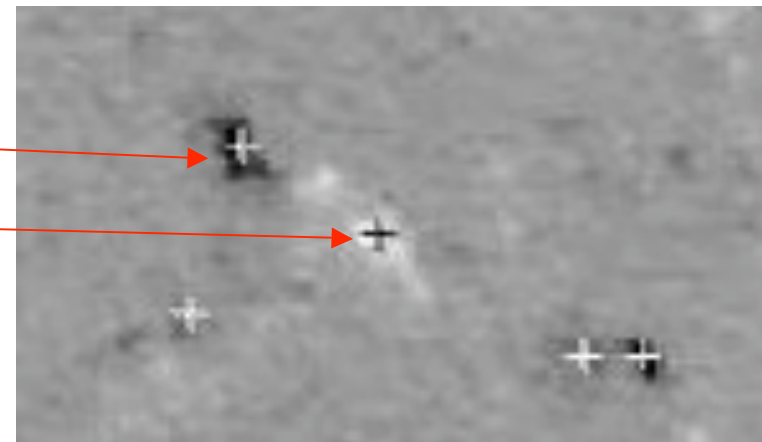
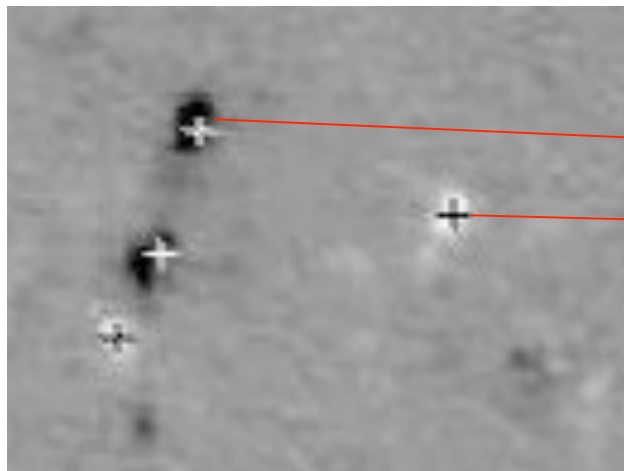
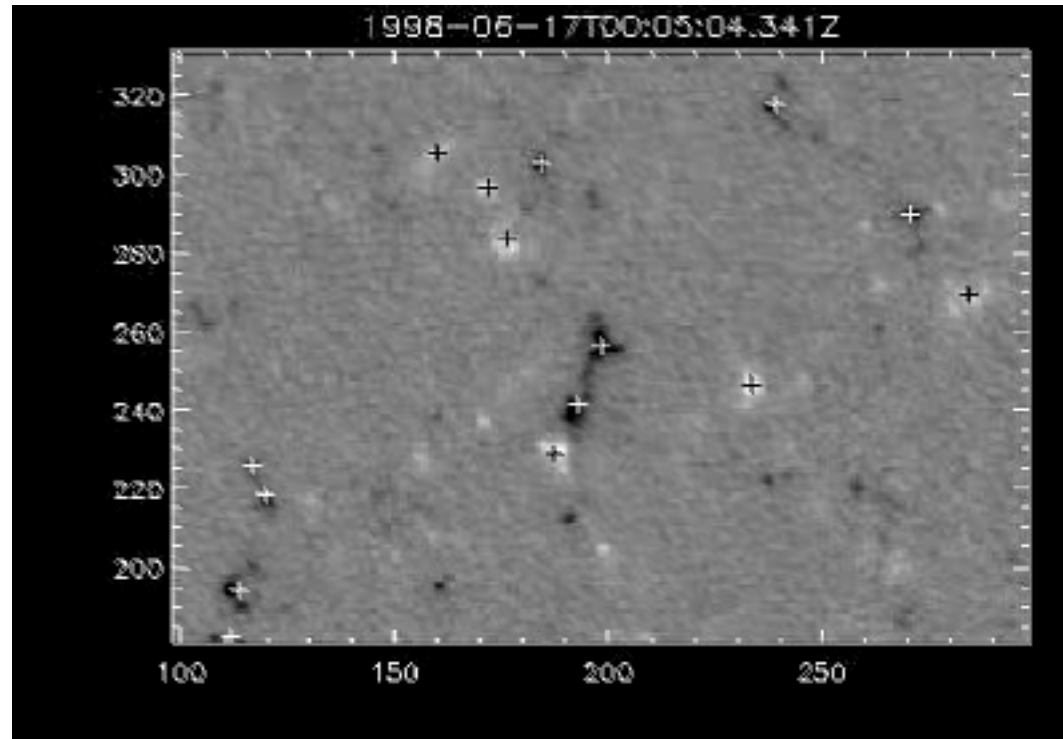

June 3, 2008

Poles approach

When 2 Poles Collide

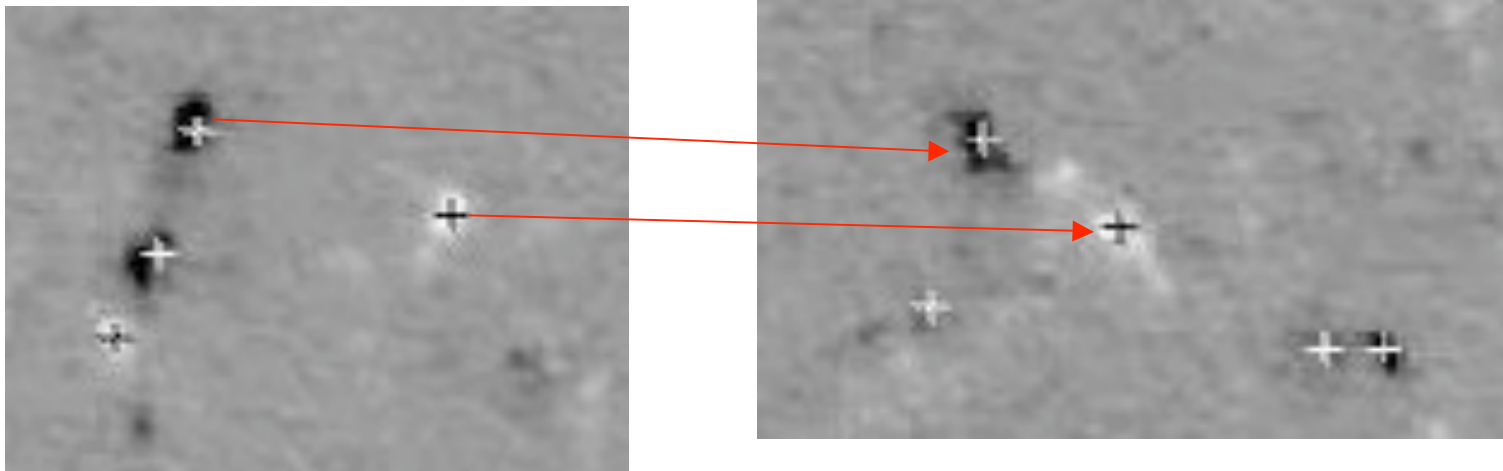
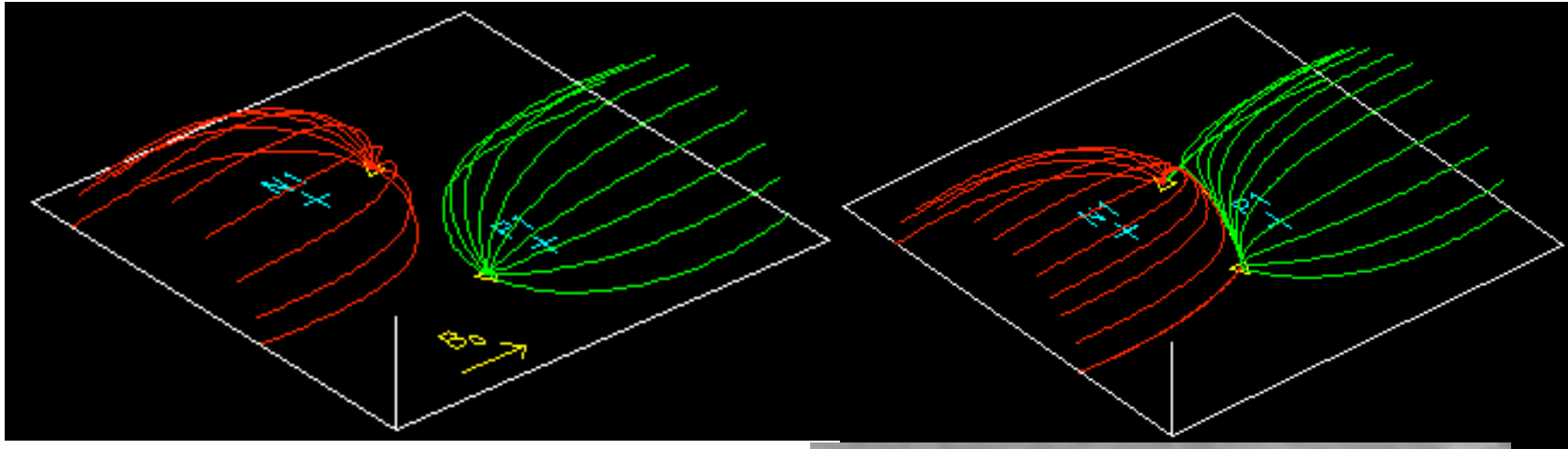

June 3, 2008 Poles approach: domains intersect

When 2 Poles Collide

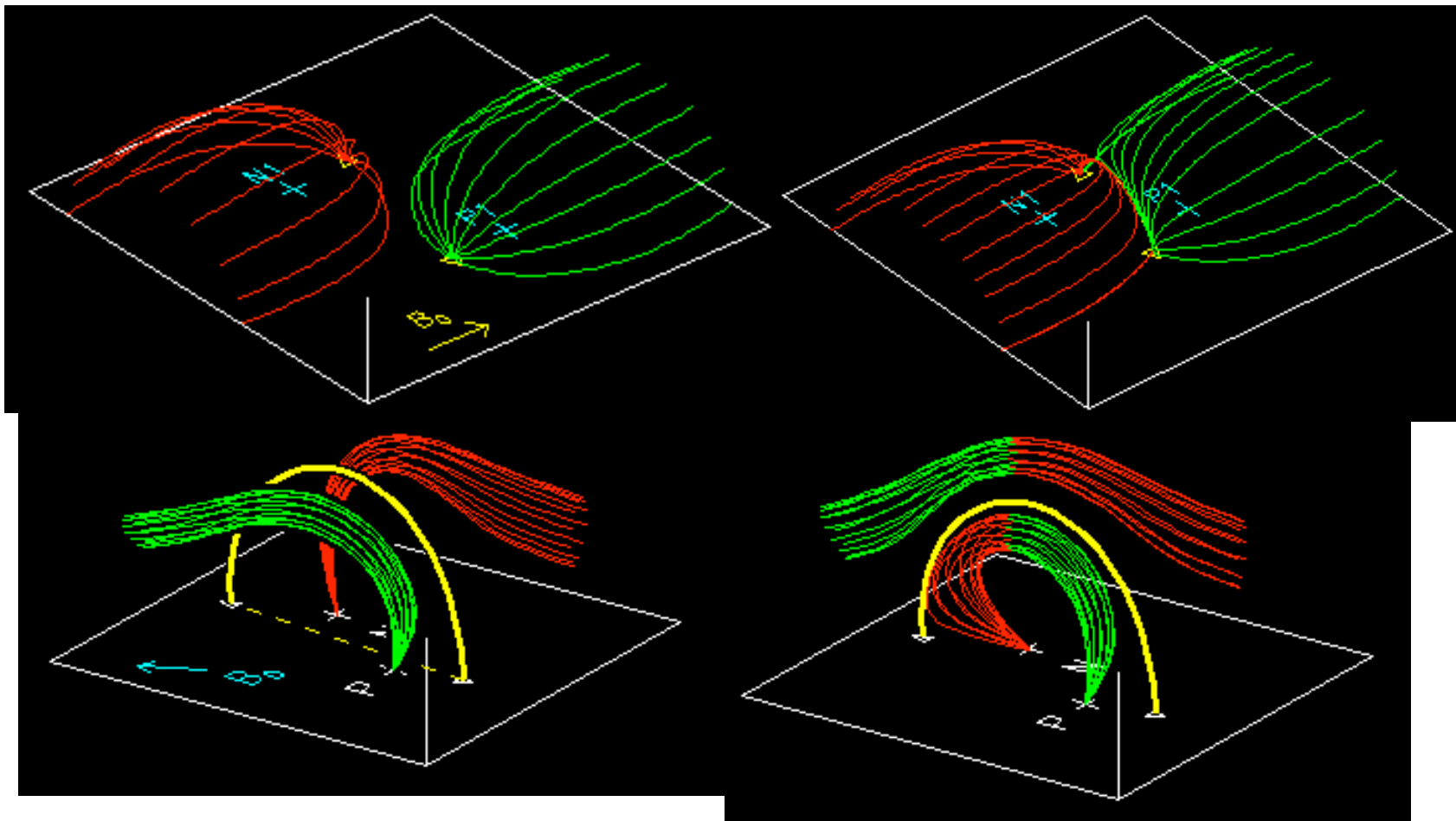

June 3, 2008

Reconnection = new field lines

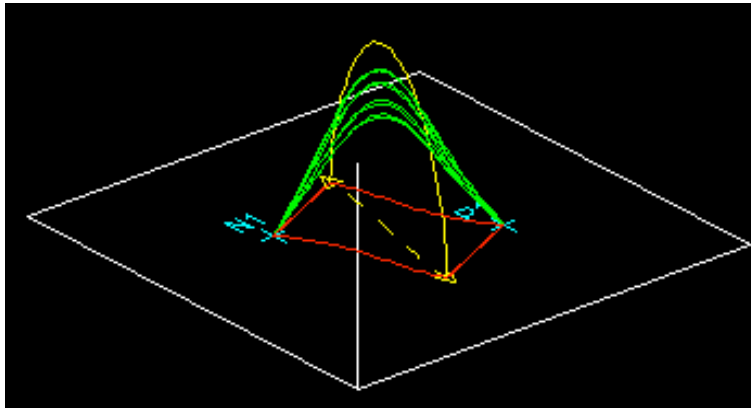

- Transfer flux: $\Delta\Psi$
- In presence of coronal current I
- Release energy

$$\Delta W = I \Delta\Psi$$

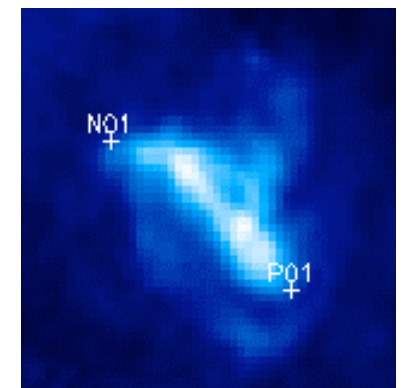
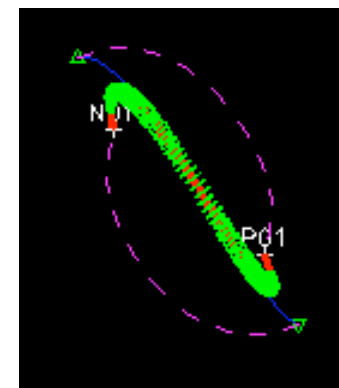
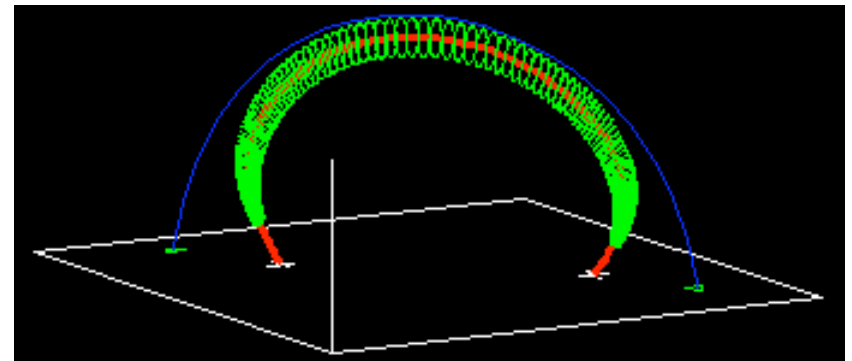
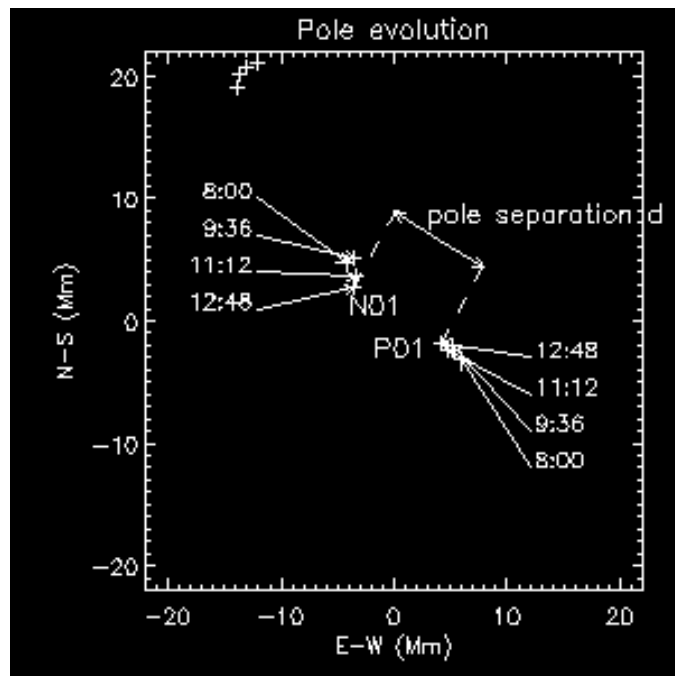

June 3, 2008 Longcope & Kankelborg 1999

Reconnection from emergence

movie

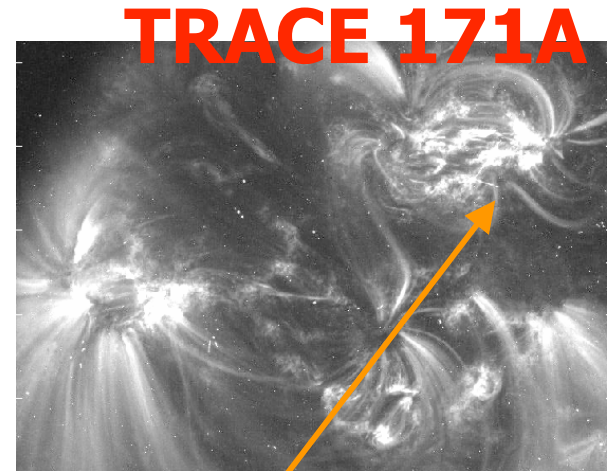
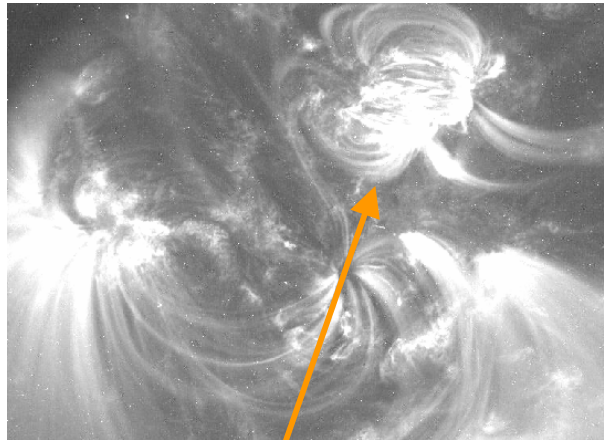
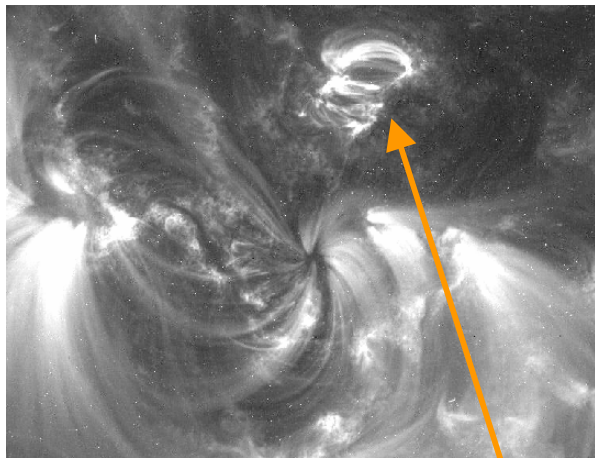

TRACE 171A

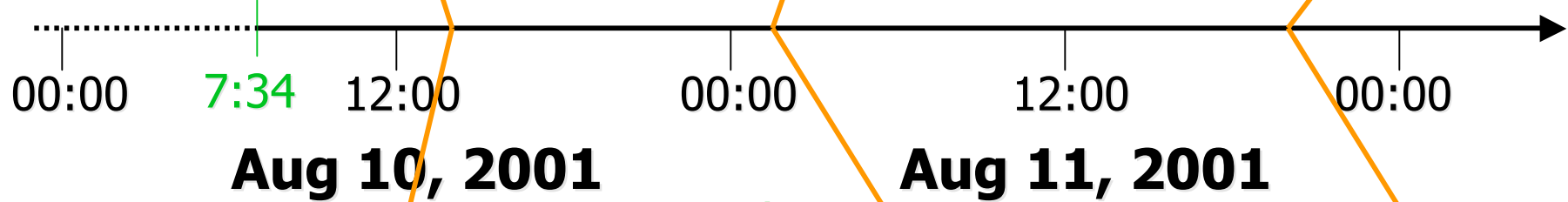

movie

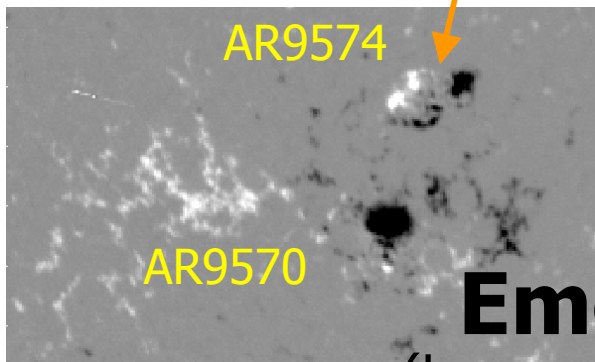

AR9574

AR9570

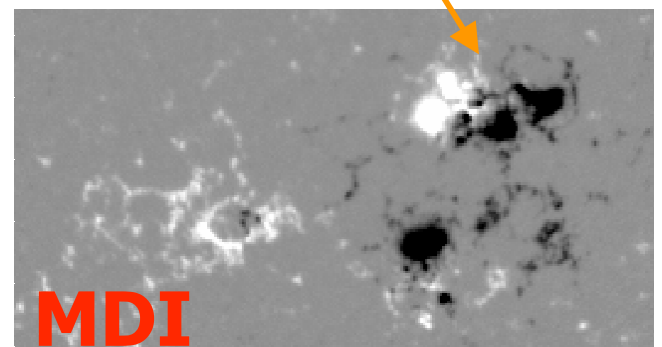
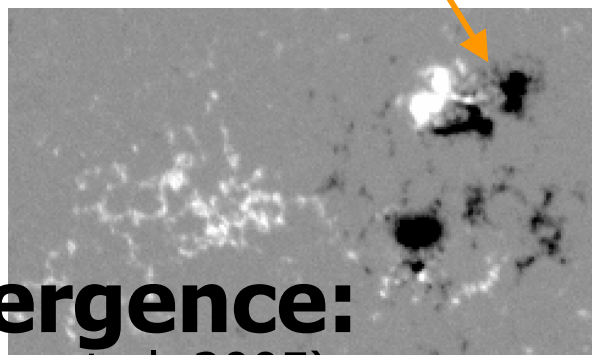

MDI

Emergence:
(Longcope et al. 2005)

Why this is reconnection

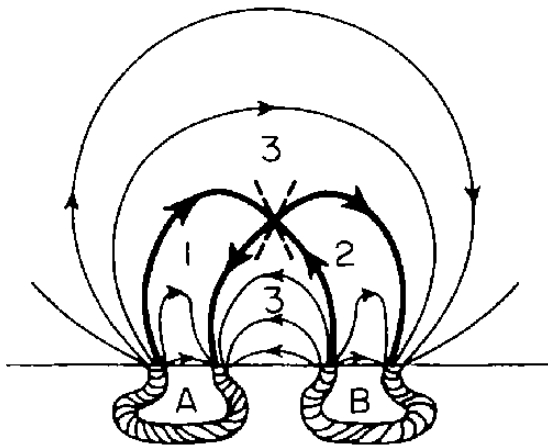

Baum &
Bratenahl
1976

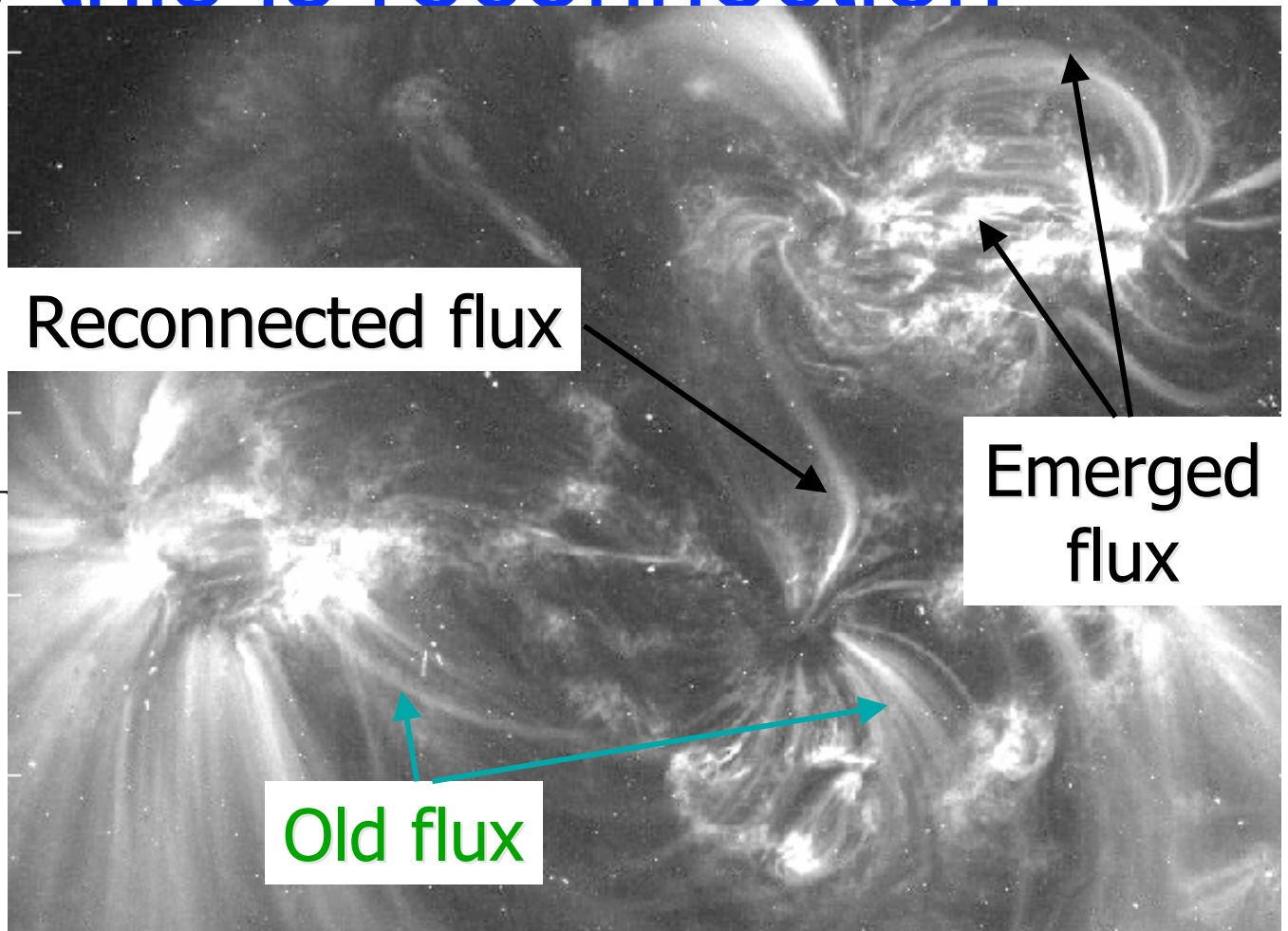

Quasi-static Evolution

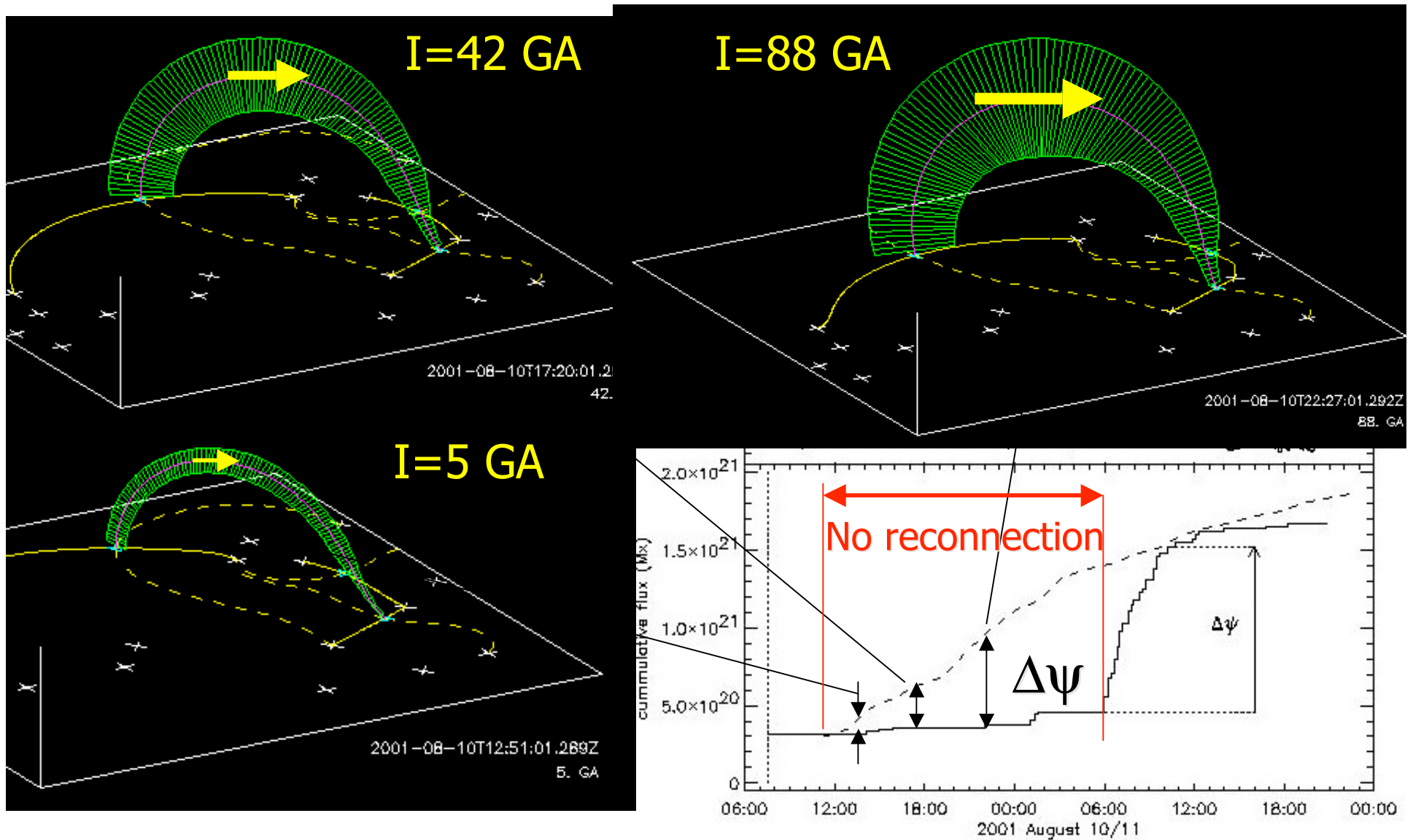

Heating then cooling

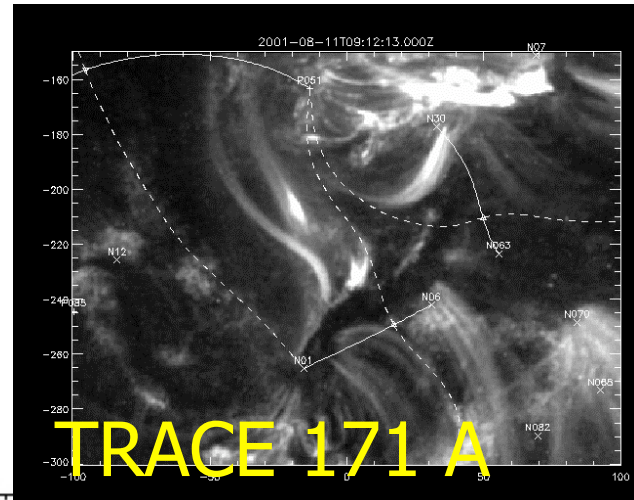
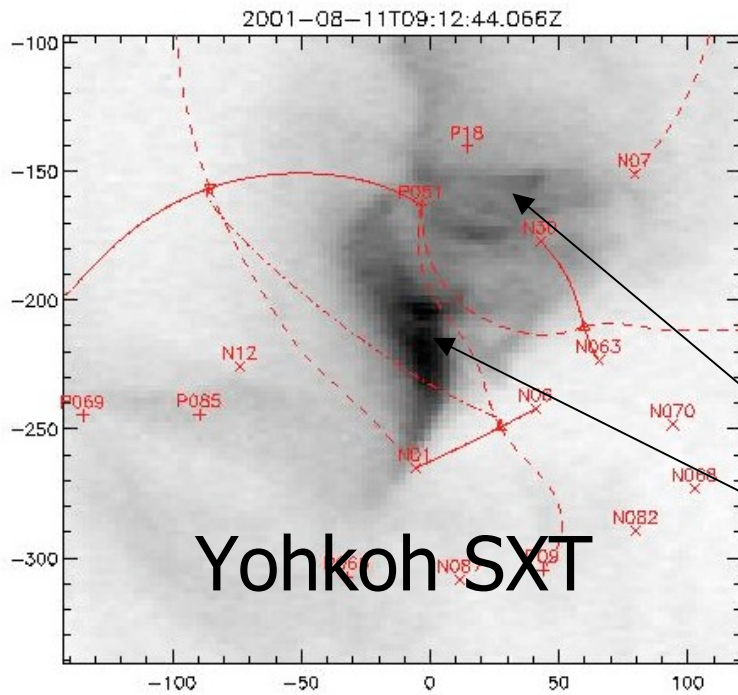

movie

Hot (~ 7.5 MK) after
reconnection...
Cool into TRACE
pass-band

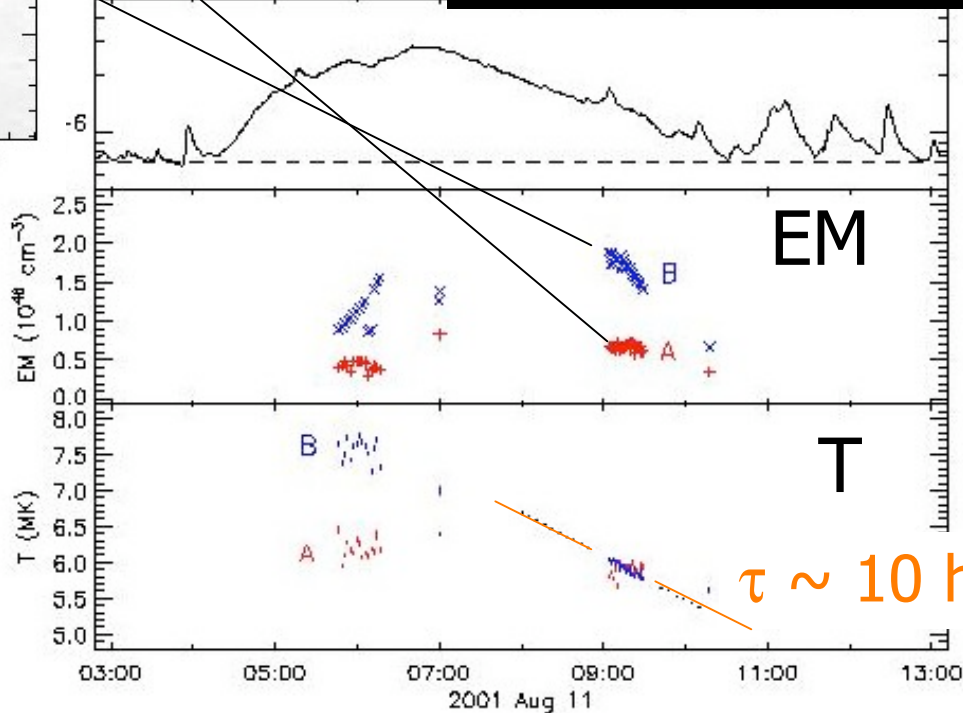

June 3, 2008

Reconnection observed

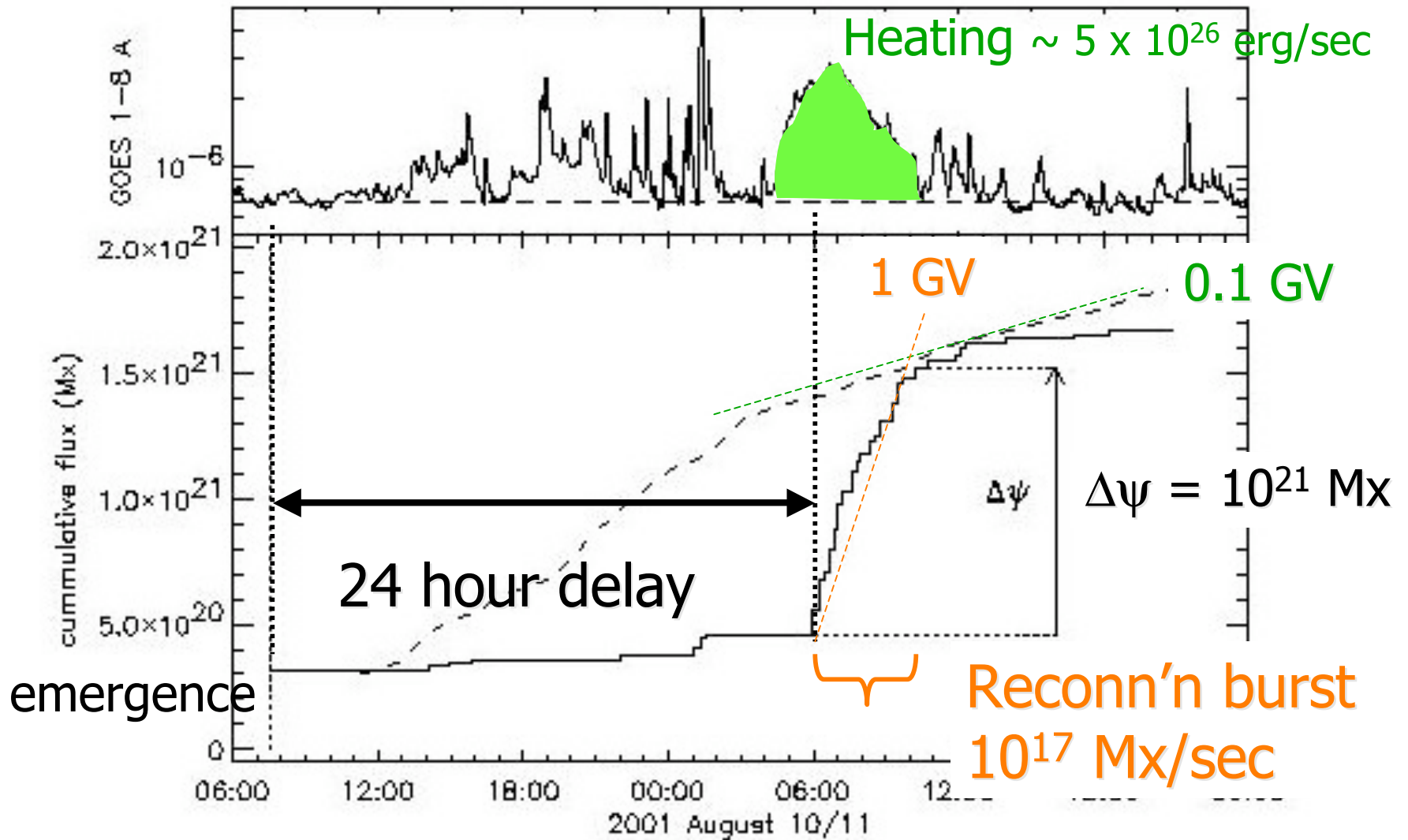

Summary

- Magnetic field reaches atmosphere from dynamo layer as slender, twisted tubes
- Twist (current) emerges into corona
- Field produces hot corona: power related to magnetic flux
- Coronal response to flux changes & emergence (reconnection) supplies heat