

# Work, Energy & Forces



**The wrong way!**



**The right way!**

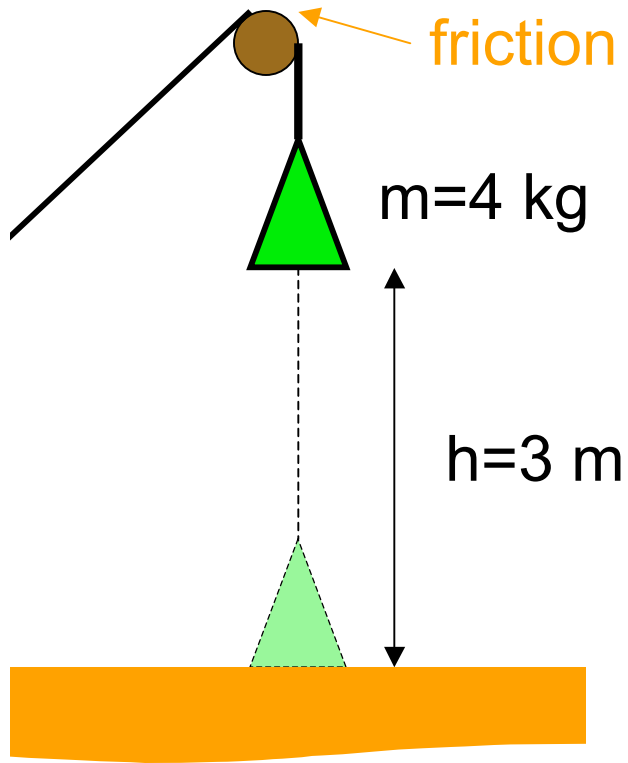

I hoist a 4 kg food bag 3 m into a tree. What is the **total net work** done on the food bag?

A -120 J

B 0 J

C +120 J

D other

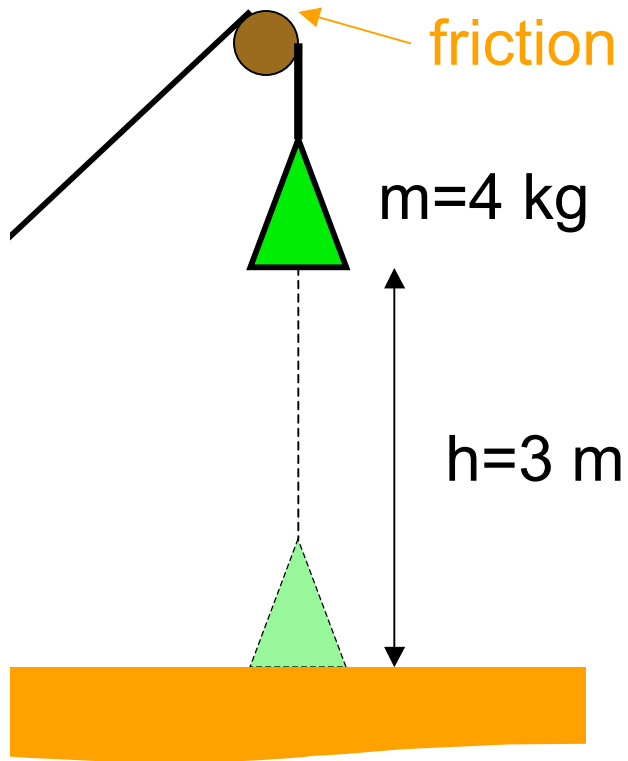

I hoist a 4 kg food bag 3 m into a tree. What is the **total net work** done on the food bag?

A -120 J

**B 0 J**

C +120 J

D other

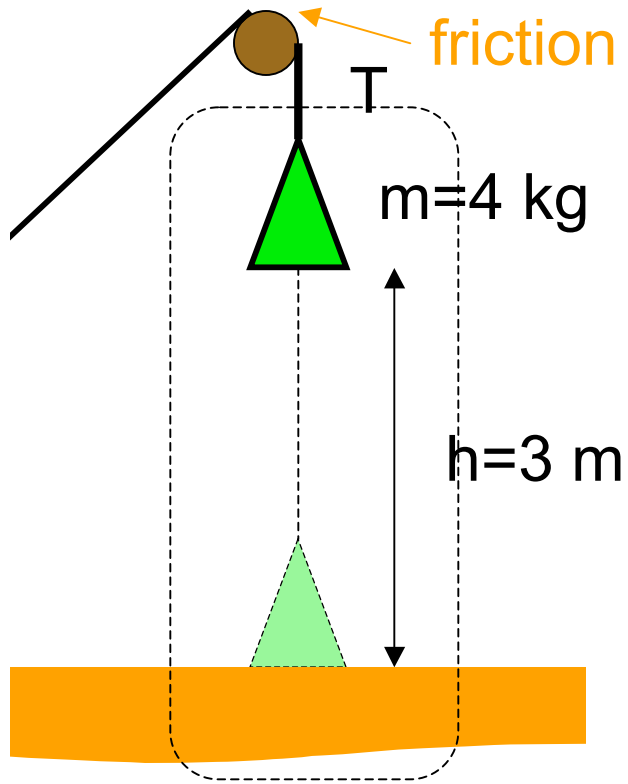

$$W = \Delta K = 0$$

I hoist a 4 kg food bag 3 m into a tree. What is the **total work** done on the food bag/Earth system?

A -120 J

B 0 J

C +120 J

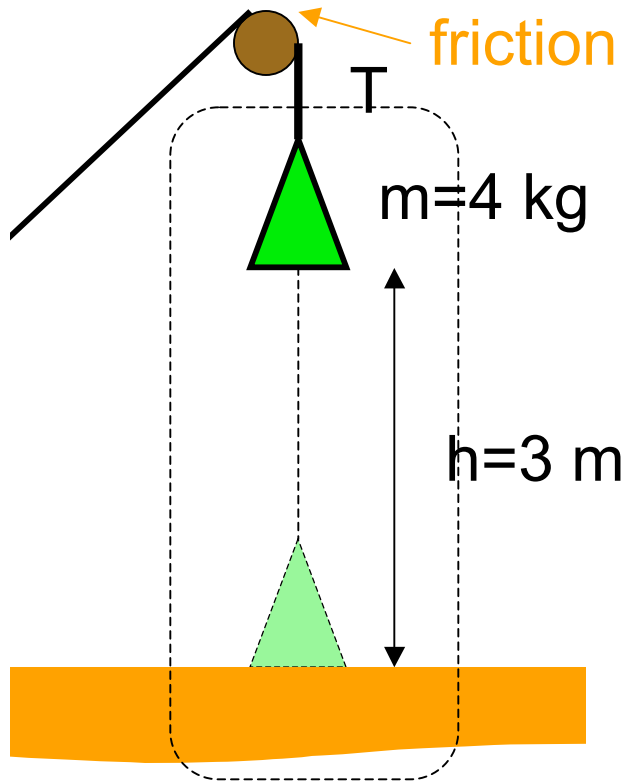

I hoist a 4 kg food bag 3 m into a tree. What is the **total work** done on the food bag/Earth system?

A -120 J

B 0 J

**C +120 J**

$$W = \Delta K = 0$$

$$W_g = -mg h = -120 \text{ J}$$

$$W_g + W_T = 0$$

$$W_T = +120 \text{ J}$$

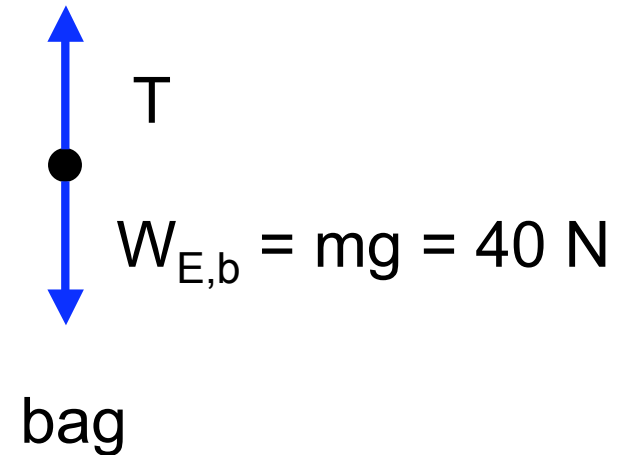

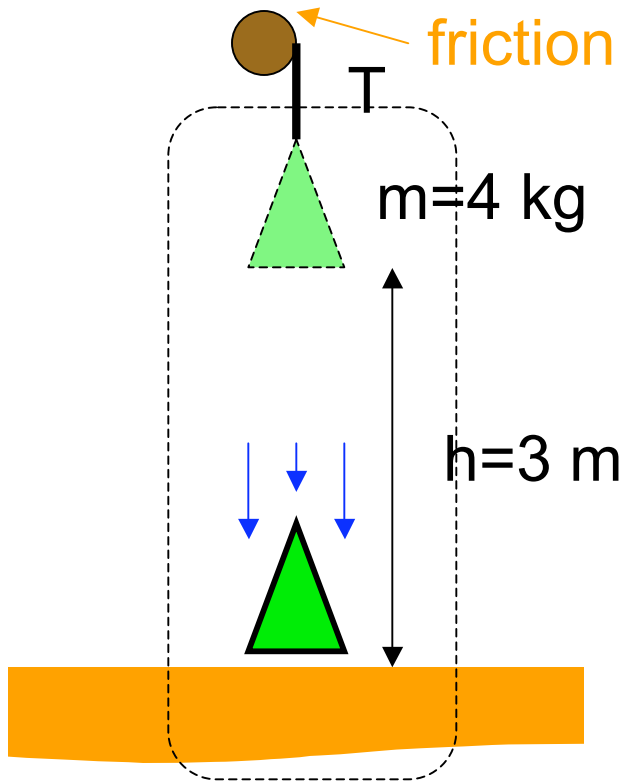

$$W = \Delta E = 0$$

A bear cuts the rope and the bag drops to the ground. What is the **total work** done on the food bag/Earth system just before the bag hits the ground?

A -120 J

**B 0 J**

C +120 J

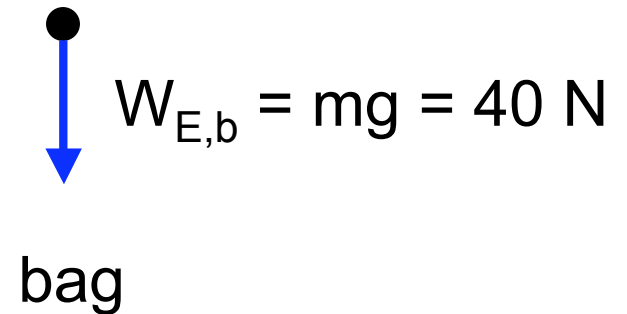

# Work/Energy Bookkeeping

Particle:

- no internal/potential energy --- only kinetic
- all forces are external

$$W = \Delta K$$

System:

- consists of multiple pieces
- potential energy in their configuration

$$W = \Delta E = \Delta K + \Delta U + \Delta E_{\text{th}}$$

# Work/Energy Bookkeeping

Particle:

- no internal/potential energy --- only kinetic
- all forces are external

work by external forces

$$W = \Delta K$$

System:

- consists of multiple pieces
- potential energy in their configuration

$$W = \Delta E = \Delta K + \Delta U + \Delta E_{th}$$

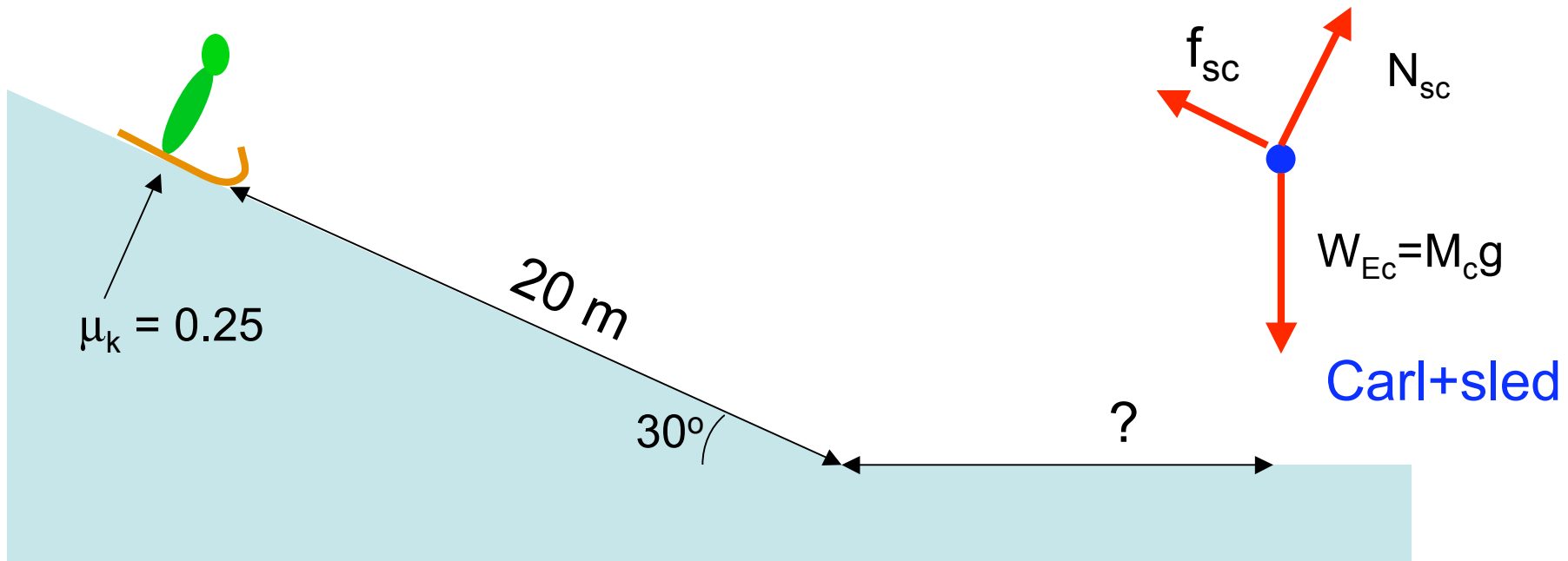

Carl sleds 20 m along a 30° hill, and then cruises on flat snow. Over the whole path he slides w/  $\mu_k = 0.25$ .

The work on the Carl+sled/earth system is

A positive

B zero

C negative

$$\Delta K + \Delta U = W$$

$$\Delta K = 0$$

$$\Delta U = mg \Delta y < 0$$

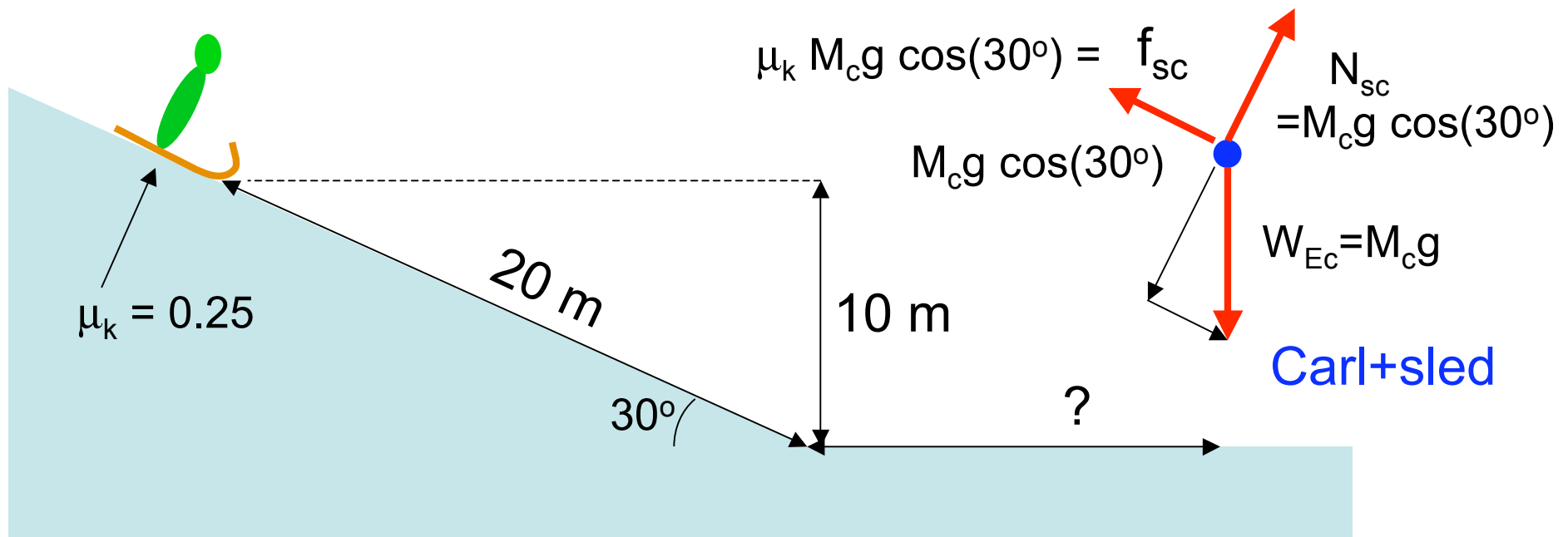

Carl sleds 20 m along a  $30^\circ$  hill, and then cruises on flat snow. Over the whole path he slides w/  $\mu_k = 0.25$ . How far does he go along the flats?

$$\Delta K + \Delta U = W$$

$$\Delta K = 0$$

$$U_i = M_c g (10 \text{ m}) \quad U_f = 0$$

$$W = -\mu_k M_c g \cos(30^\circ) 20 \text{ m} - \mu_k M_c g \Delta x$$

$$= -\mu_k M_c g [\cos(30^\circ) 20 \text{ m} + \Delta x]$$

$$\Delta x = 40 \text{ m} - 20 \cos(30^\circ) = 22.7 \text{ m}$$

A 2 kg block is pressed 10 cm into a spring with  $k = 200 \text{ N/m}$  and released to slide on a surface with  $\mu_k = 0.4$ . How far does it slide?

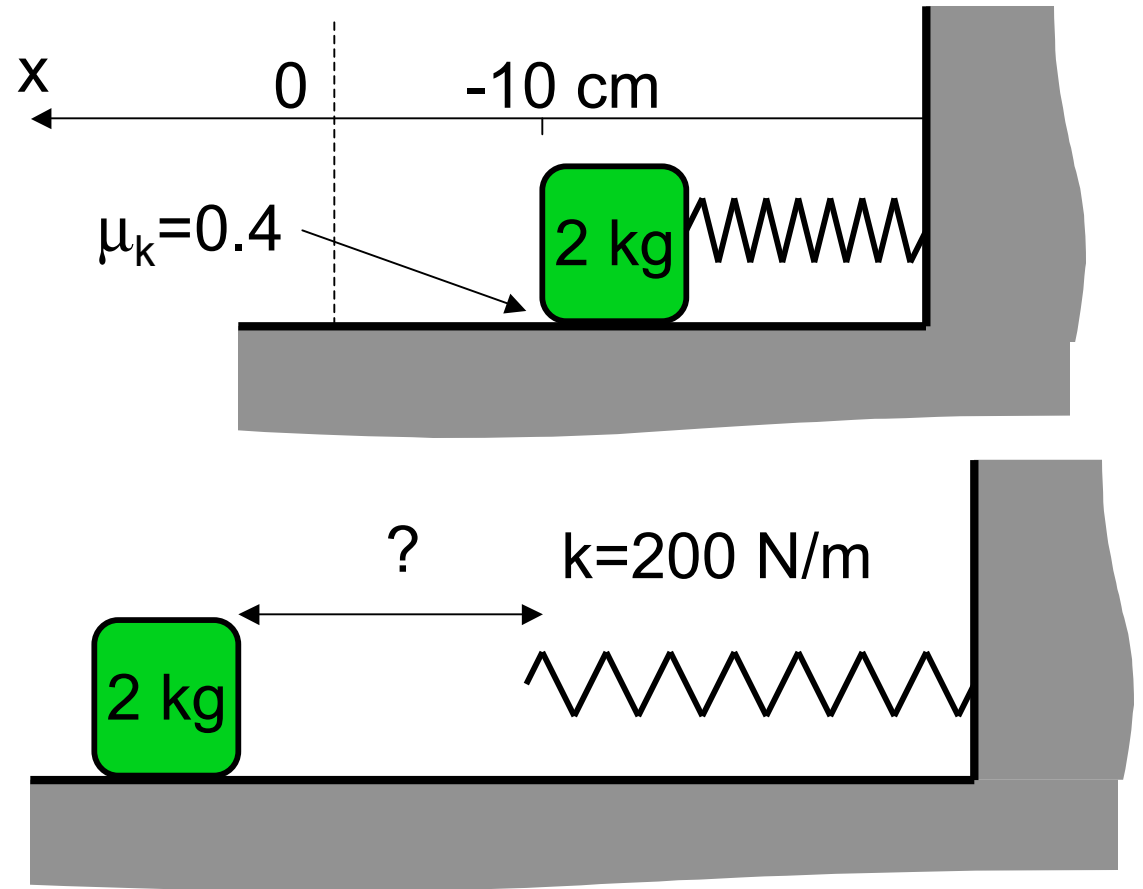

approach:

A  $\Delta K = W$

B  $\Delta K + \Delta U = 0$

C  $\Delta K + \Delta U = W$

D  $\Sigma F_x = ma_x$

of spring

from kinetic friction  
(external)

block/spring system

A 2 kg block is pressed 10 cm into a spring with  $k = 200 \text{ N/m}$  and released to slide on a surface with  $\mu_k = 0.4$ . How far does it slide?

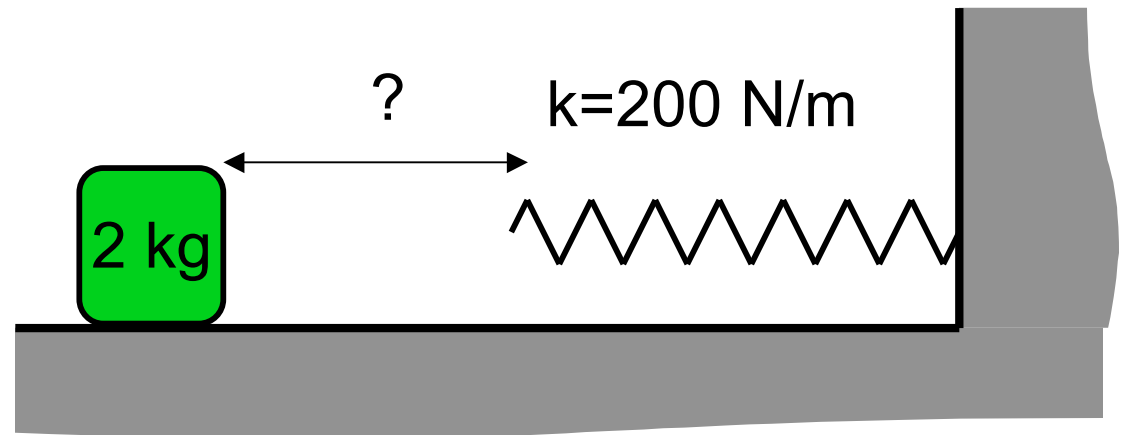
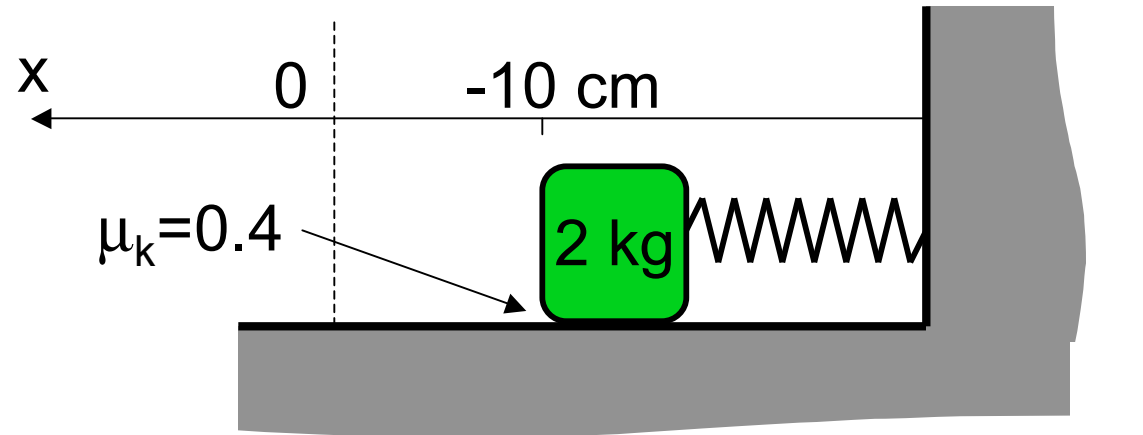

$$\Delta K + \Delta U = W$$

$$\Delta K = 0$$

$$U_i = 0.5 k x_i^2 = 1.0 \text{ J}$$

$$N_{fb} = mg = 20 \text{ N}$$

$$f_{fb} = -\mu_k N_{fb} = -8 \text{ N}$$

$$W_f = -(8 \text{ N})\Delta x$$

I. assume  $x_f > 0$

$$U_f = 0$$

$$\Delta U = -1.0 \text{ J} = W$$

$$\Delta x = 1 \text{ J} / 8 \text{ N} = 0.125 \text{ m}$$

$x_f = +0.025 \text{ m}$

A 2 kg block is pressed 10 cm into a spring with  $k = 100 \text{ N/m}$  and released to slide on a surface with  $\mu_k = 0.4$ . How far does it slide?

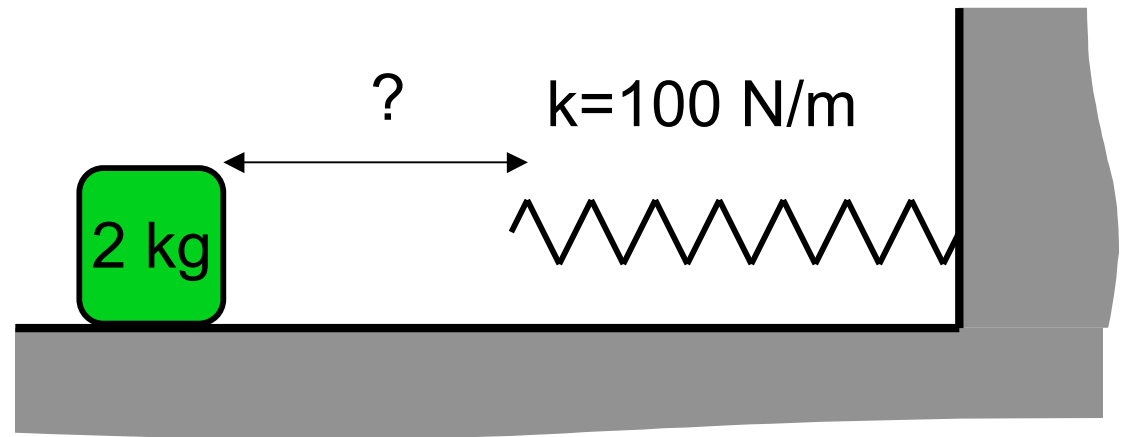
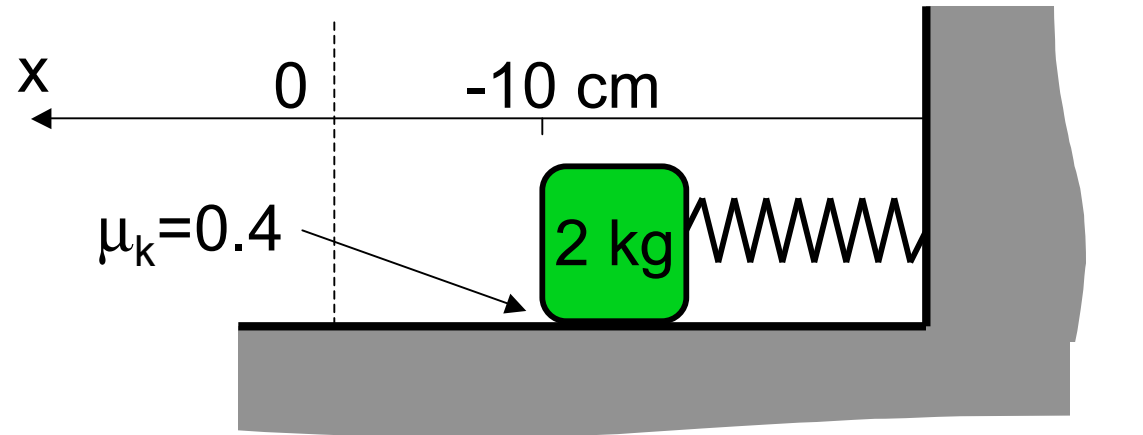

$$\Delta K + \Delta U = W$$

$$\Delta K = 0$$

$$U_i = 0.5 k x_i^2 = 0.5 \text{ J}$$

$$N_{fb} = mg = 20 \text{ N}$$

$$f_{fb} = -\mu_k N_{fb} = -8 \text{ N}$$

$$W_f = -(8 \text{ N})\Delta x$$

I. assume  $x_f > 0$

$$U_f = 0$$

$$\Delta U = -1.0 \text{ J} = W$$

$$\Delta x = 1 \text{ J} / 8 \text{ N} = 0.0625 \text{ m}$$

✘  $x_f = -0.0375 \text{ m}$

A 2 kg block is pressed 10 cm into a spring with  $k = 100 \text{ N/m}$  and released to slide on a surface with  $\mu_k = 0.4$ . How far does it slide?

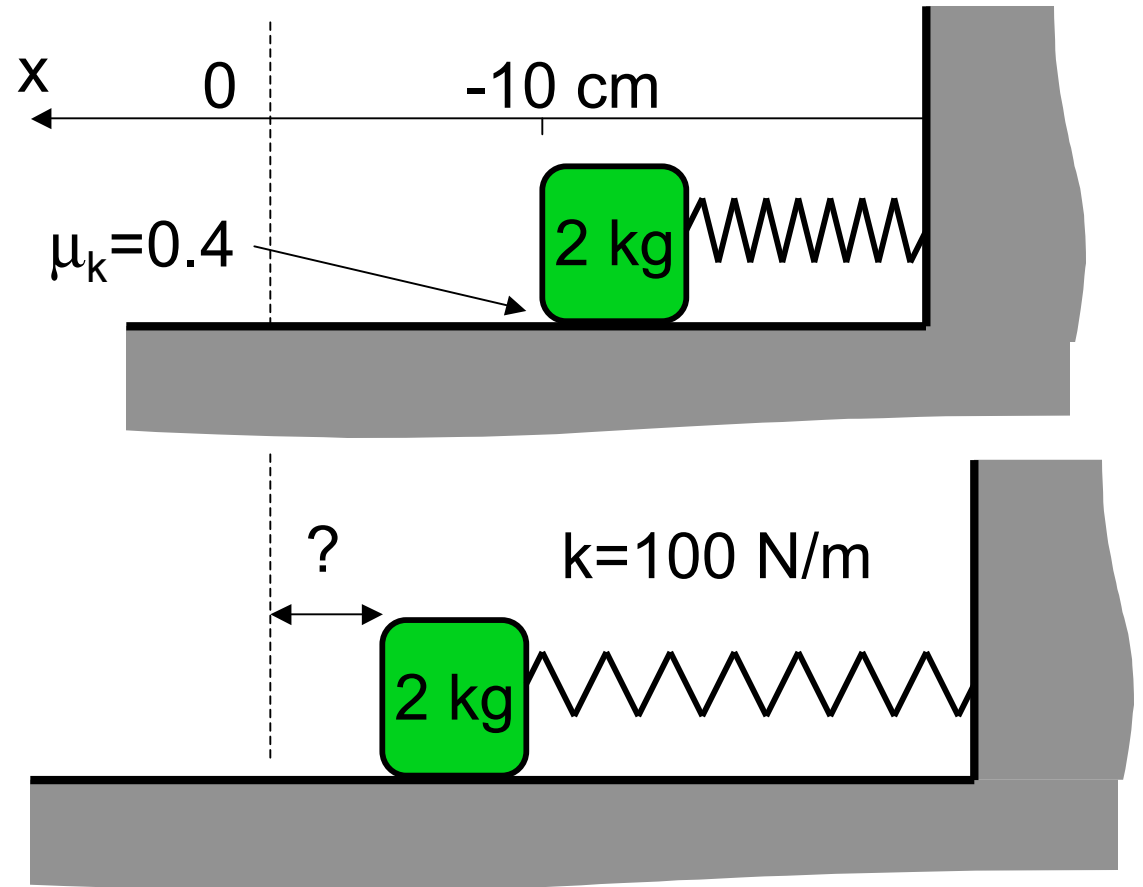

$$\Delta K + \Delta U = W$$

$$\Delta K = 0$$

$$U_i = 0.5 k x_i^2 = 0.5 \text{ J}$$

$$N_{fb} = mg = 20 \text{ N}$$

$$f_{fb} = -\mu_k N_{fb} = -8 \text{ N}$$

$$W_f = -(8 \text{ N})\Delta x$$

II. assume  $x_f < 0$

$$50 x_f^2 + 8 x_f + 0.3 = 0$$

$$U_f = 0.5 k x_f^2 = 50 x_f^2$$

$$W_f = -0.8 \text{ J} - 8 x_f$$

$$x_f = -0.06 \text{ m}$$

$$x_f = \frac{-8 \pm \sqrt{64 - 4(50)(0.3)}}{100} = -0.08 \pm .02$$

A 2 kg block is pressed 10 cm into a spring with  $k = 200 \text{ N/m}$  and released to slide on a surface with  $\mu_k = 0.4$ . Where is it moving fastest and how fast is it moving?

- A At end of spring ( $x = 0$ )
- B At outset ( $x = -10 \text{ cm}$ )
- C Somewhere before end of spring ( $-10 \text{ cm} < x < 0$ )**
- D Beyond the end of the spring ( $x > 0$ )

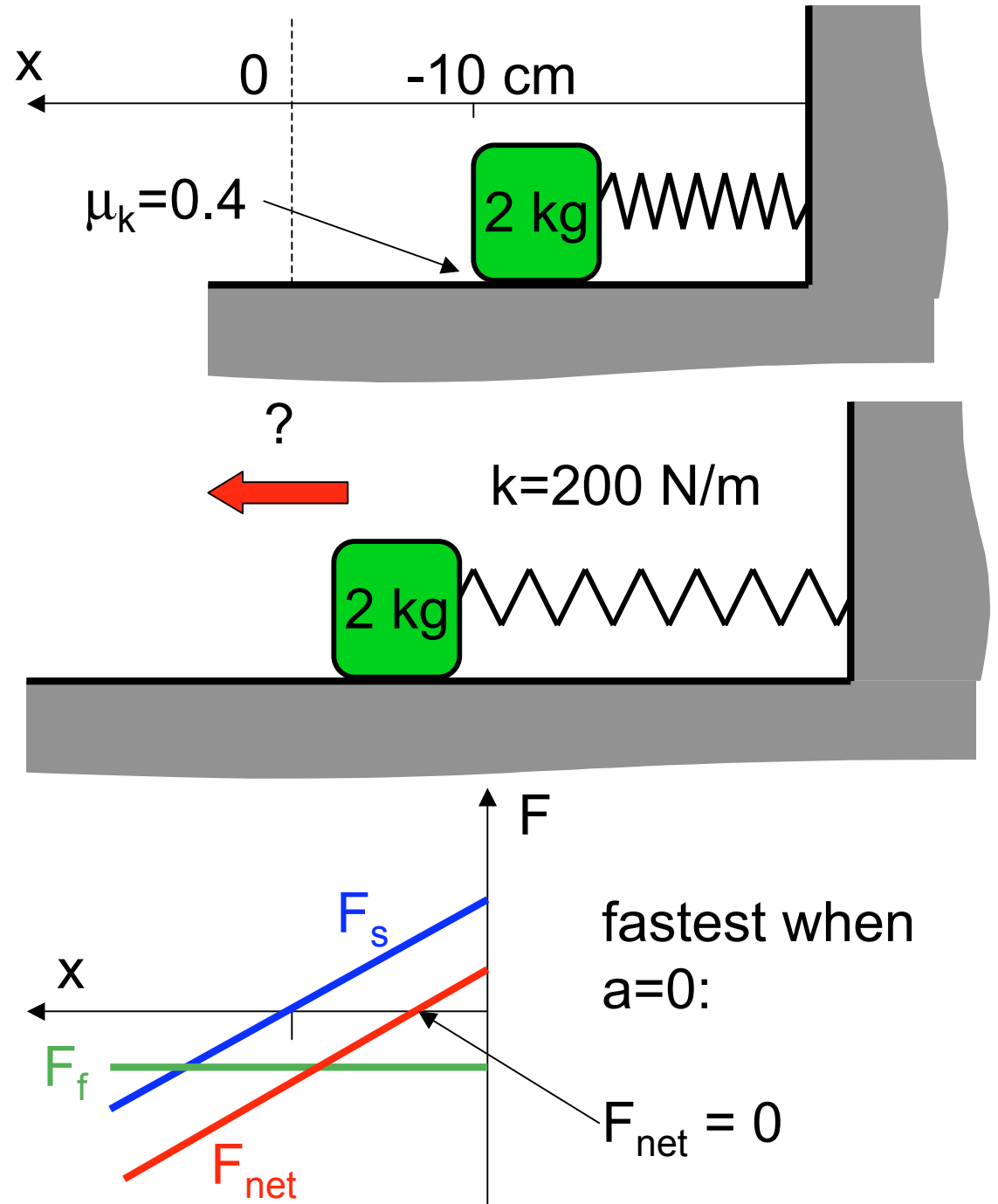

A 2 kg block is pressed 10 cm into a spring with  $k = 200 \text{ N/m}$  and released to slide on a surface with  $\mu_k = 0.4$ . Where is it moving fastest and how fast is it moving?

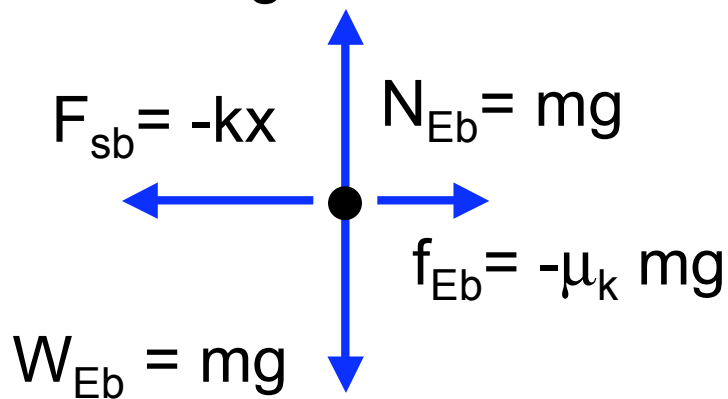

What if  $x_i = 0.08 \text{ m}$ ?

What if  $x_i = 0.03 \text{ m}$ ?

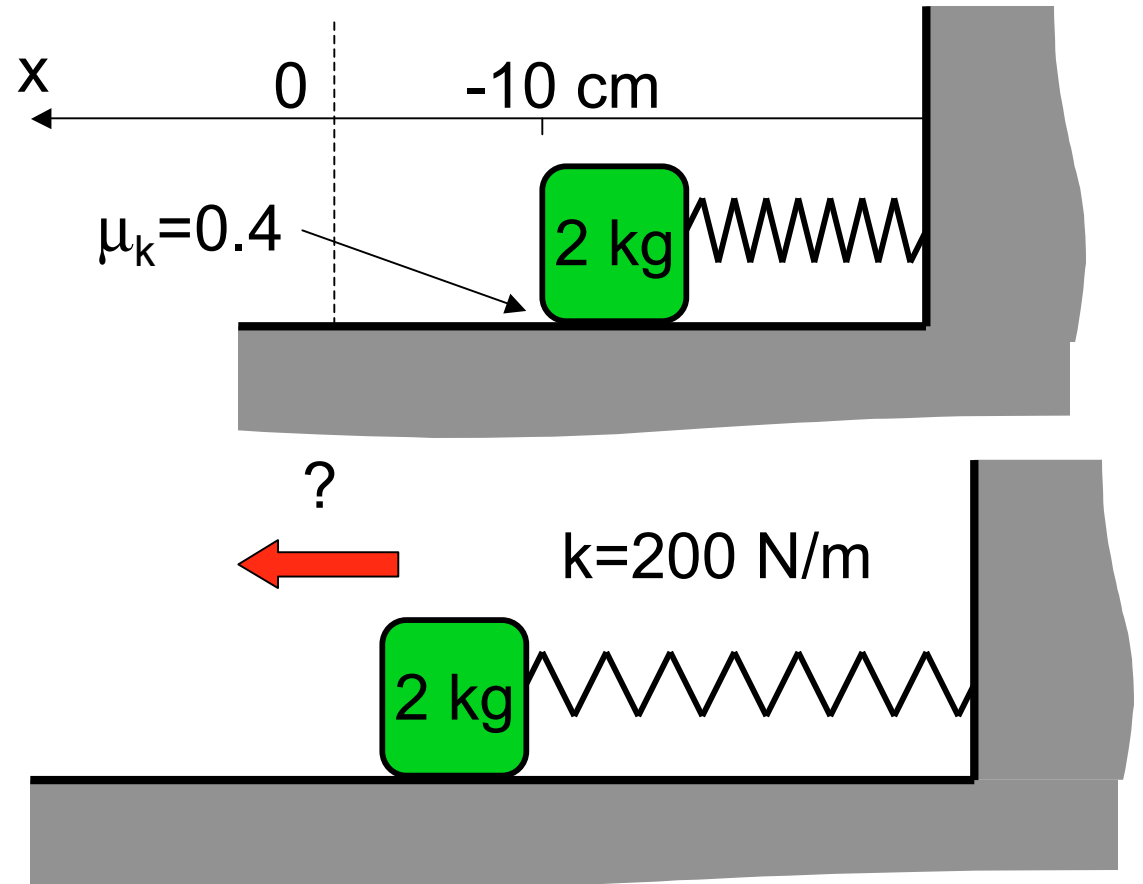

fastest when  $a = 0$ :

$$F_{\text{net}} = -kx - \mu_k mg = 0$$

$$x = -\mu_k mg/k = -0.04 \text{ m}$$

A 2 kg block is pressed 10 cm into a spring with  $k = 200 \text{ N/m}$  and released to slide on a surface with  $\mu_k = 0.4$ . Where is it moving fastest and how fast is it moving?

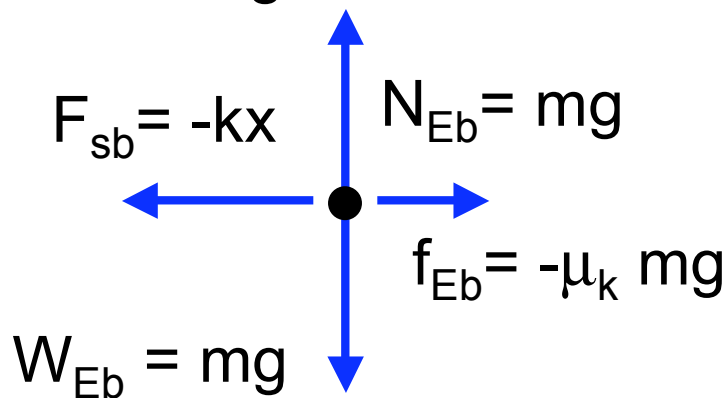

block

$$K_f = \sum W = 0.36 \text{ J}$$

$$v_f = 0.6 \text{ m/s}$$

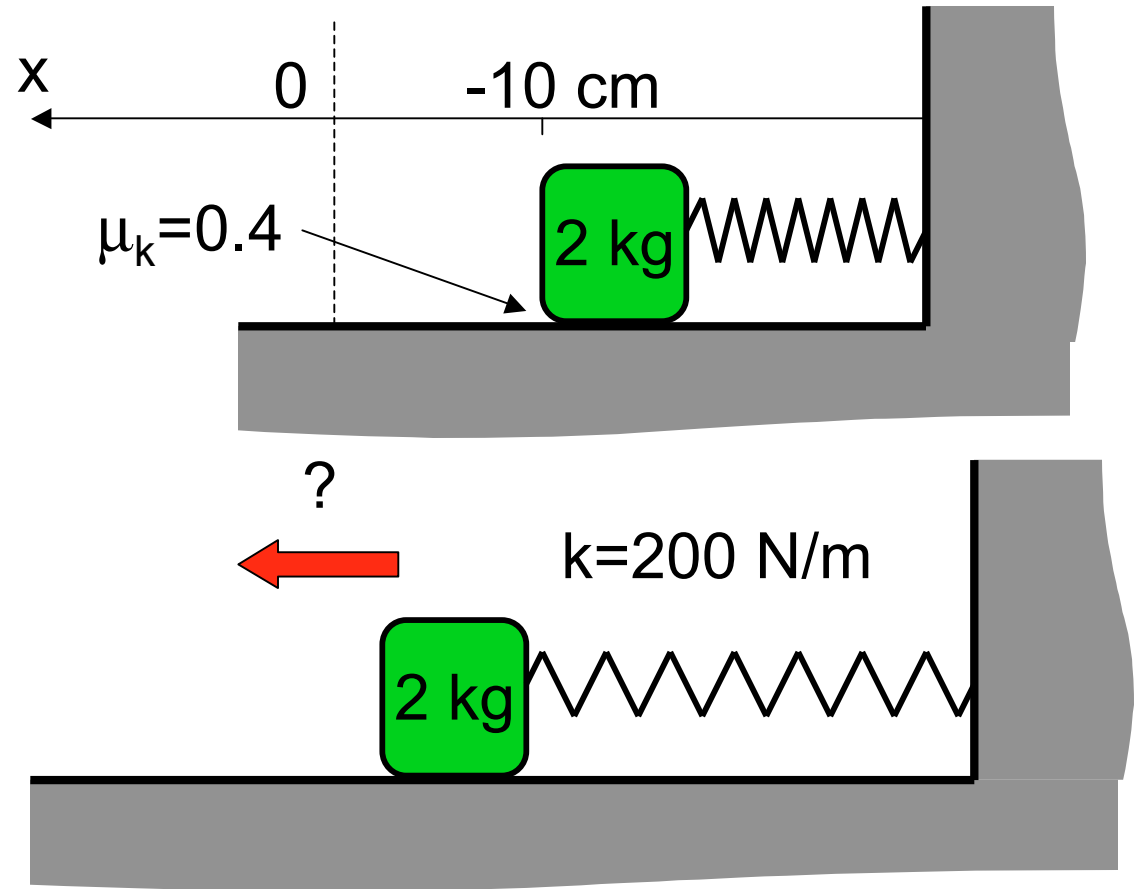

$$x = -\mu_k mg/k = -0.04 \text{ m}$$

$$W_f = -(8 \text{ N})(0.06 \text{ m}) = -0.48 \text{ J}$$

$$W_s = 0.5 k x_i^2 - 0.5 k x_f^2 = 0.84 \text{ J}$$

railcar rolls frictionlessly along tracks ...

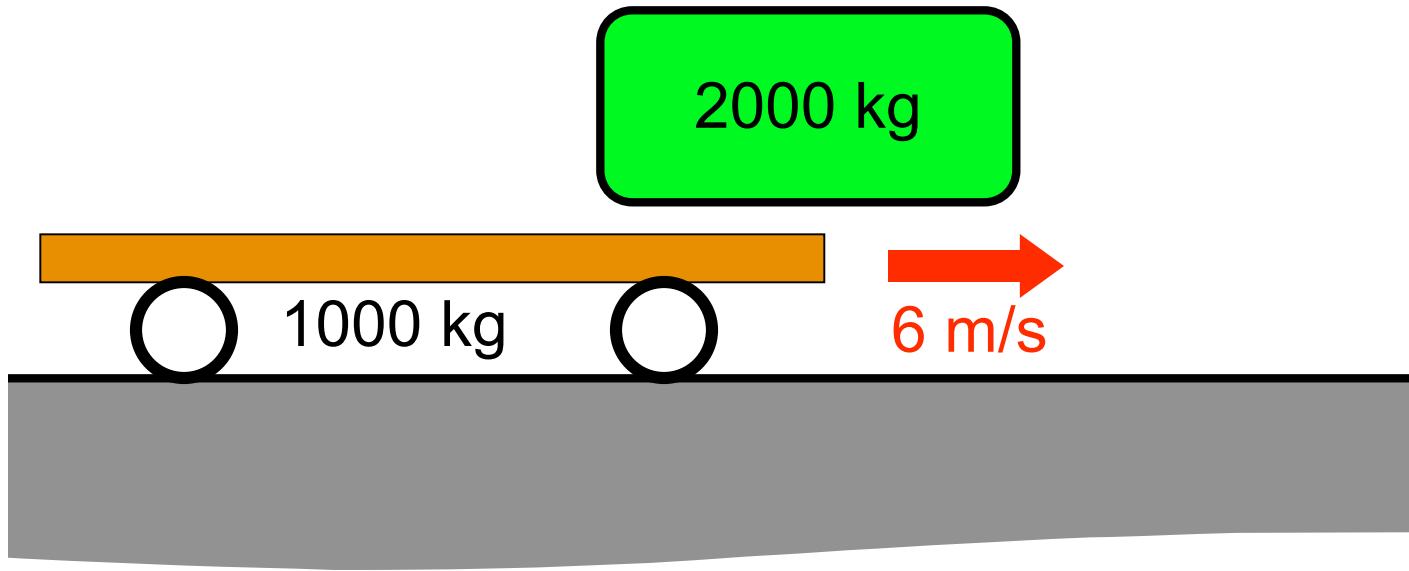

railcar rolls frictionlessly along tracks ...

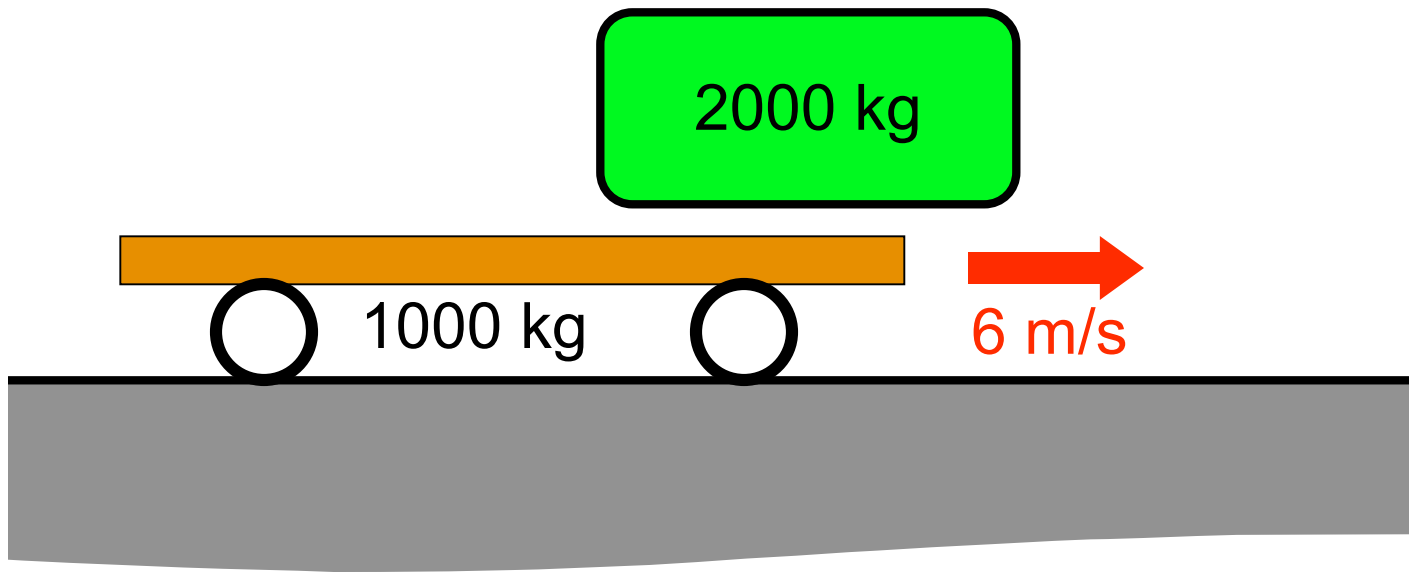

... container drops onto it, slides with  $\mu_k = 0.5$

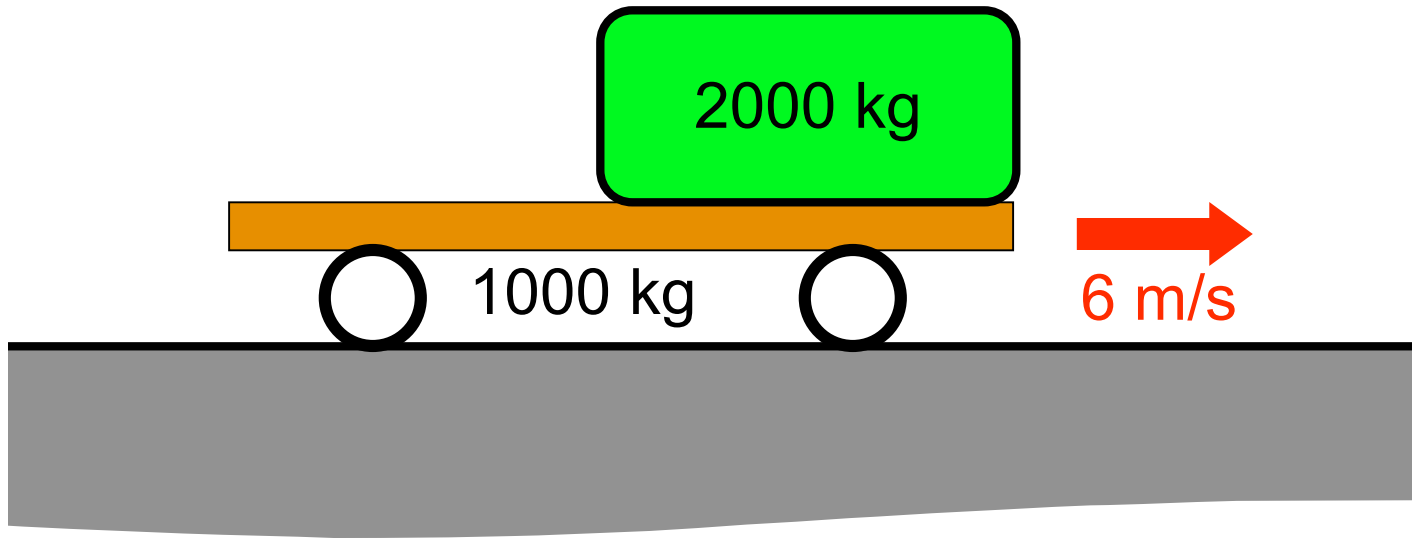

... container drops onto it, slides with  $\mu_k = 0.5$

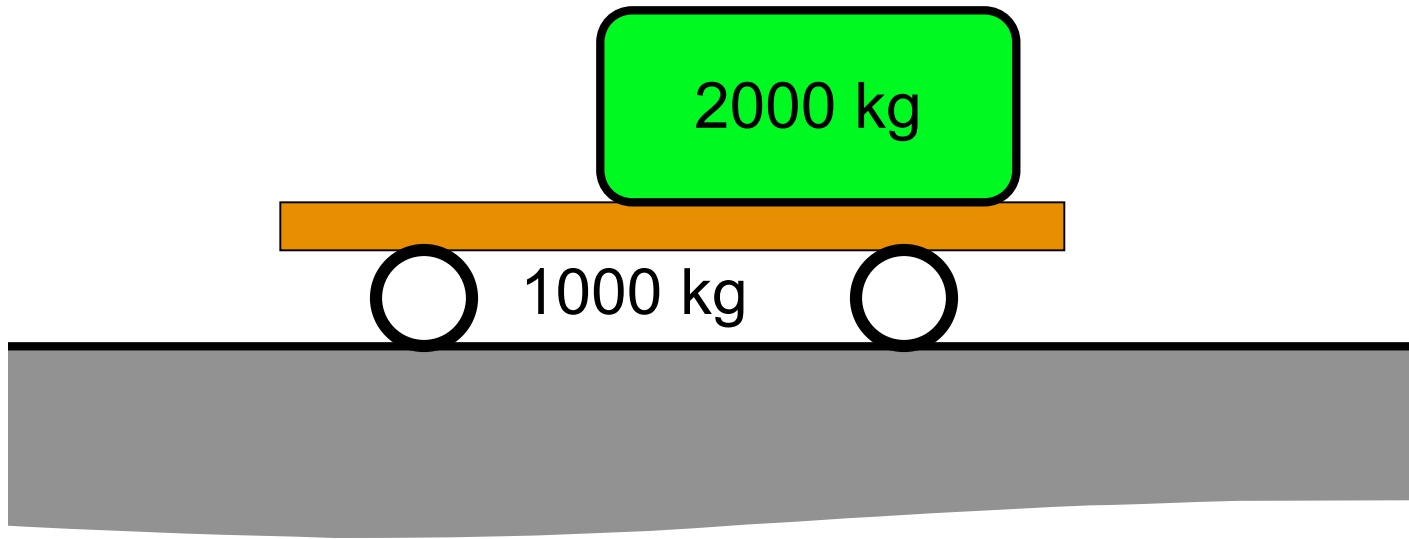

... container drops onto it, slides with  $\mu_k = 0.5$

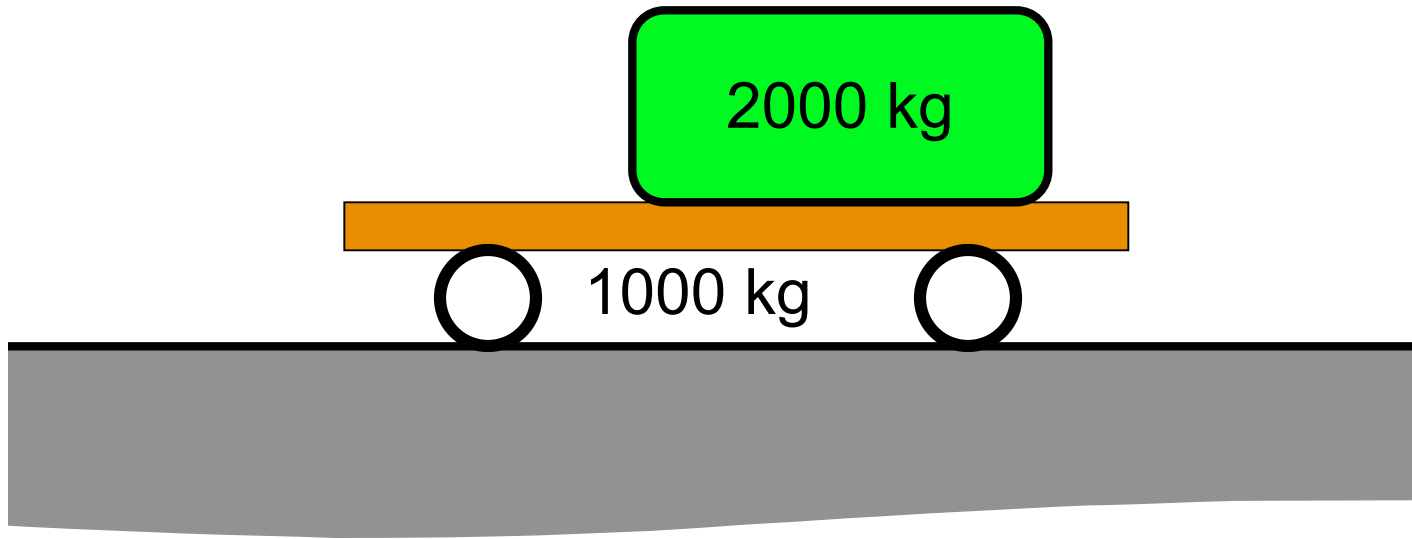

... container drops onto it, slides with  $\mu_k = 0.5$

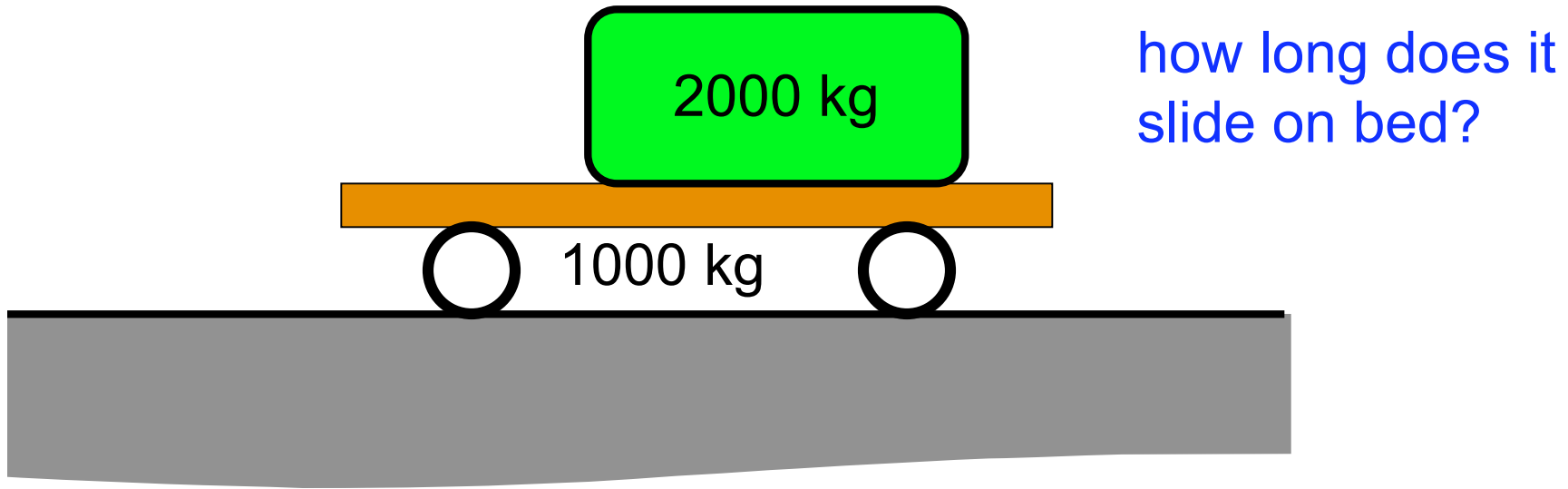

Draw FBDs for each:  
railcar & container

Find acceleration of  
each one

... container drops onto it, slides with  $\mu_k = 0.5$

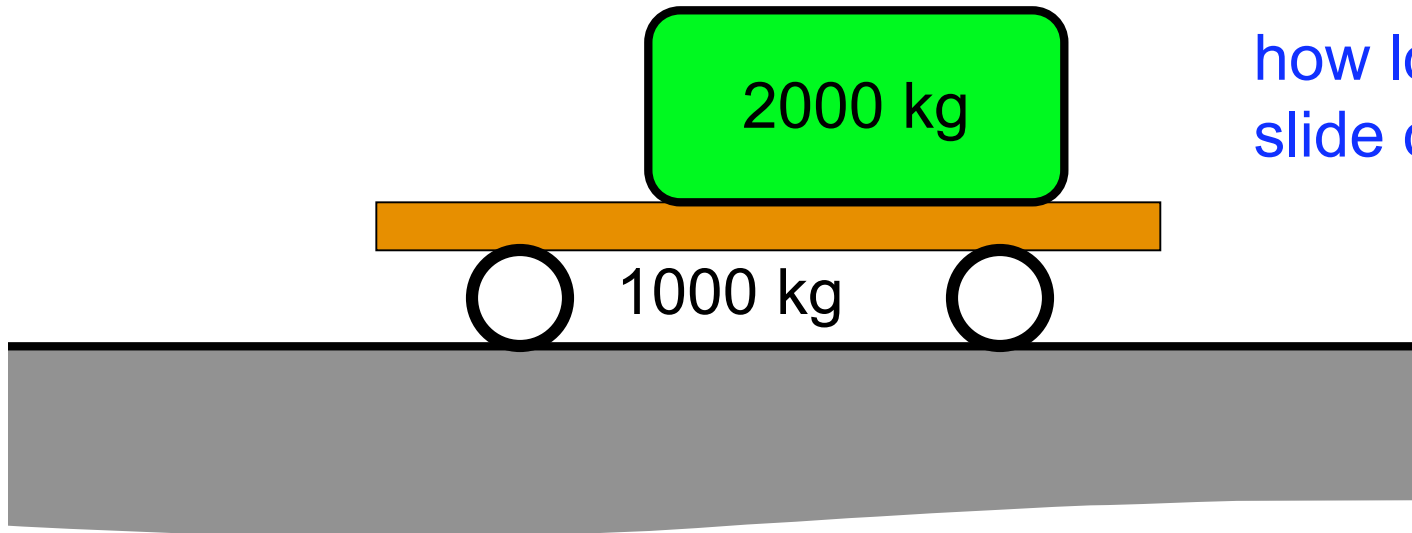

how long does it slide on bed?

$$a_c = 5 \text{ m/s}^2$$
$$a_r = -10 \text{ m/s}^2$$

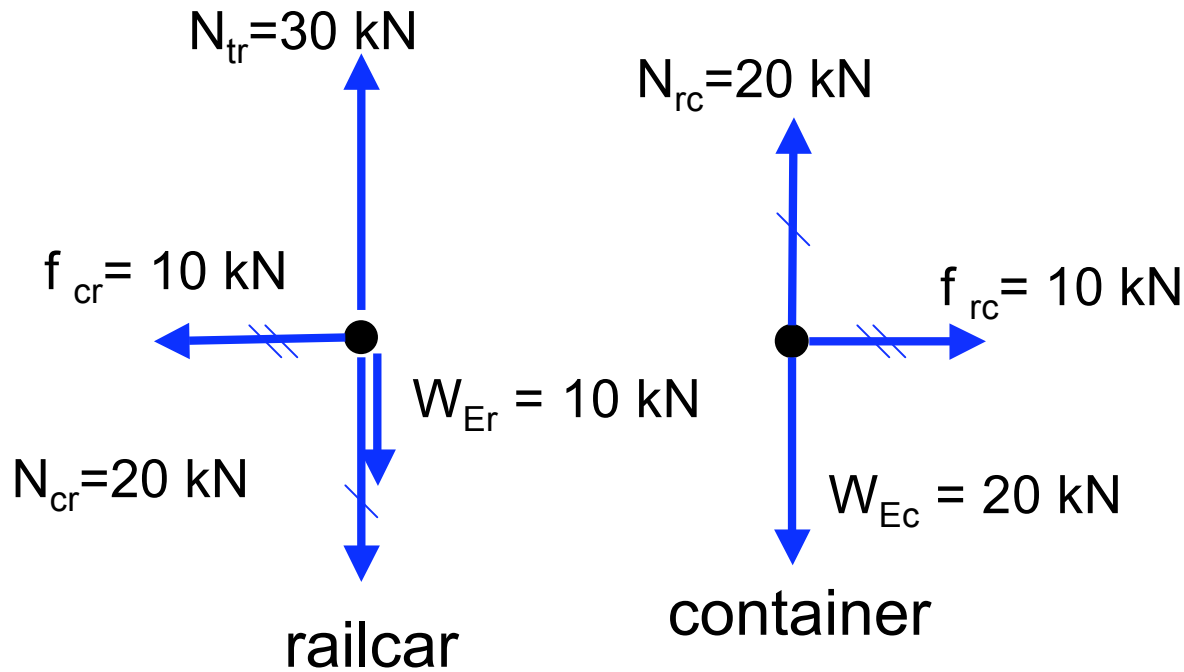

container drops onto it, slides with  $\mu_k = 0.5$

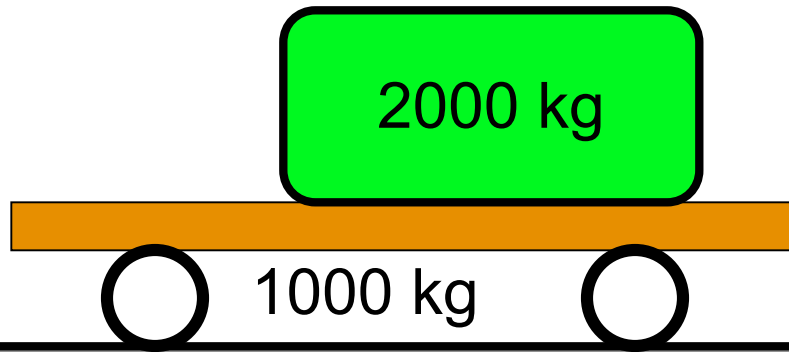

how long does it slide on bed?

$a_c = 5 \text{ m/s}^2$   
 $a_r = -10 \text{ m/s}^2$

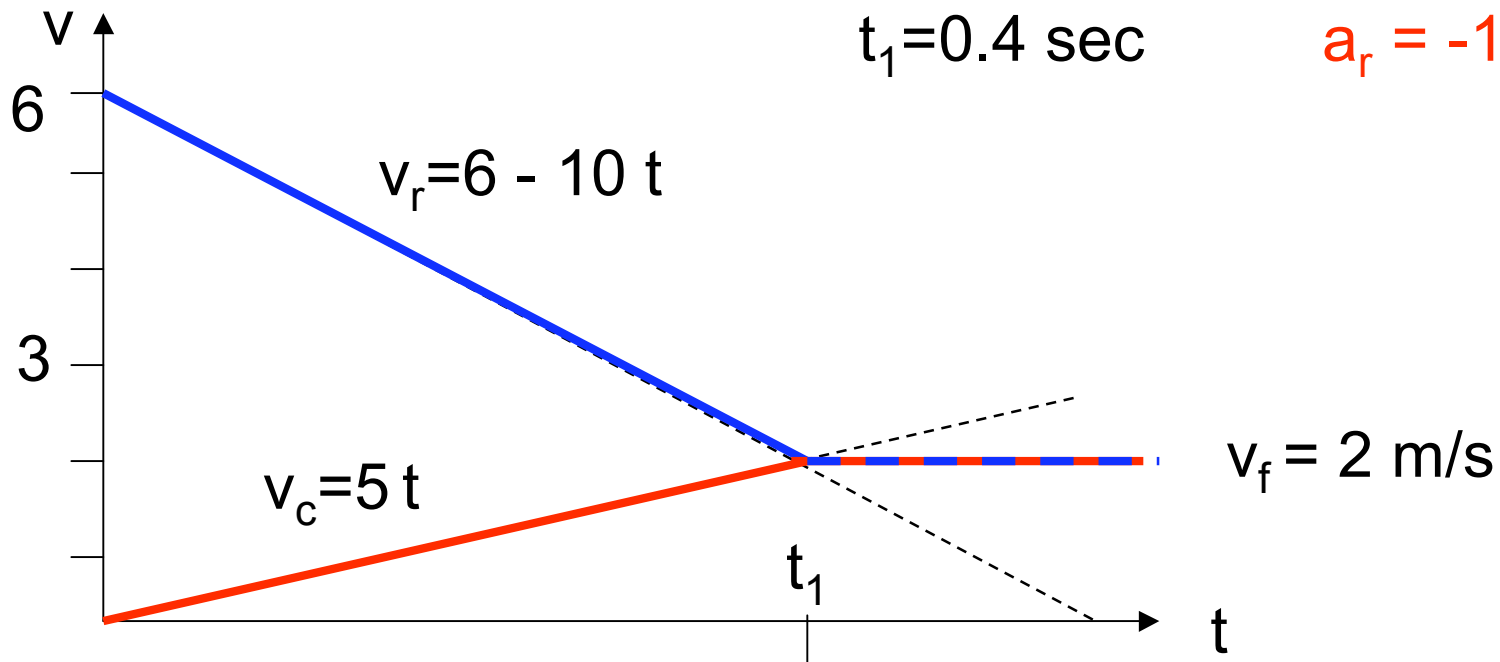

container drops onto it, slides with  $\mu_k = 0.5$

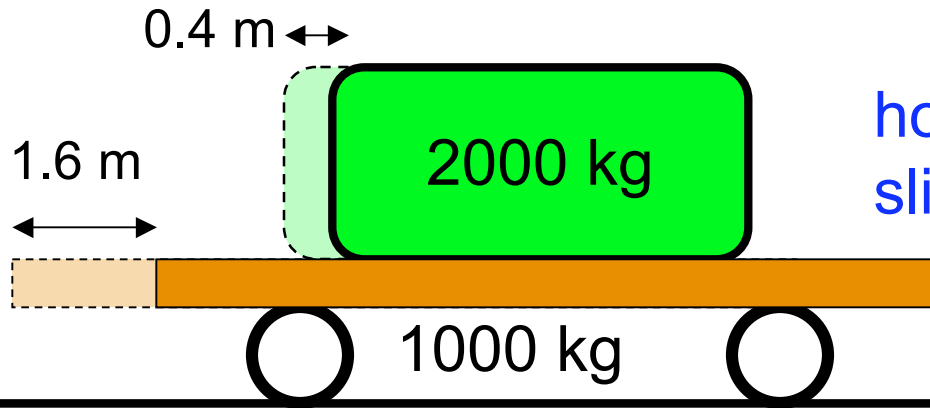

how long does it slide on bed?

$a_c = 5 \text{ m/s}^2$   
 $a_r = -10 \text{ m/s}^2$

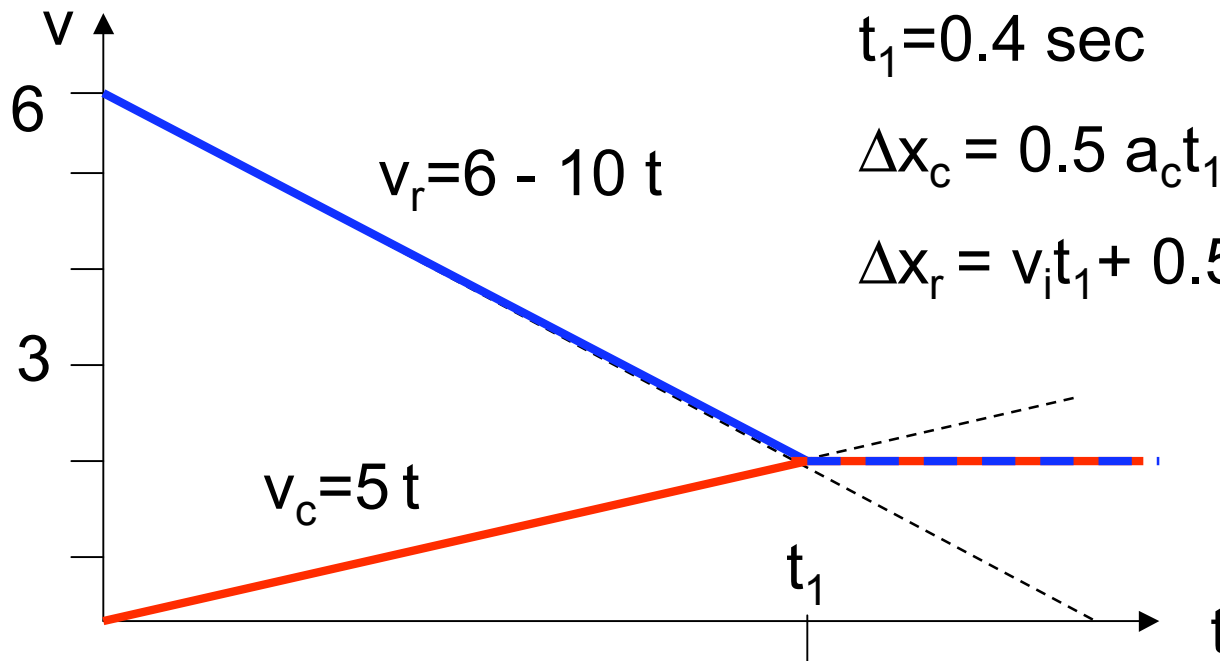

$t_1 = 0.4 \text{ sec}$

$\Delta x_c = 0.5 a_c t_1^2 = 0.4 \text{ m}$

$\Delta x_r = v_i t_1 + 0.5 a_r t_1^2 = 1.6 \text{ m}$

$v_f = 2 \text{ m/s}$

railcar rolls frictionlessly along tracks ...

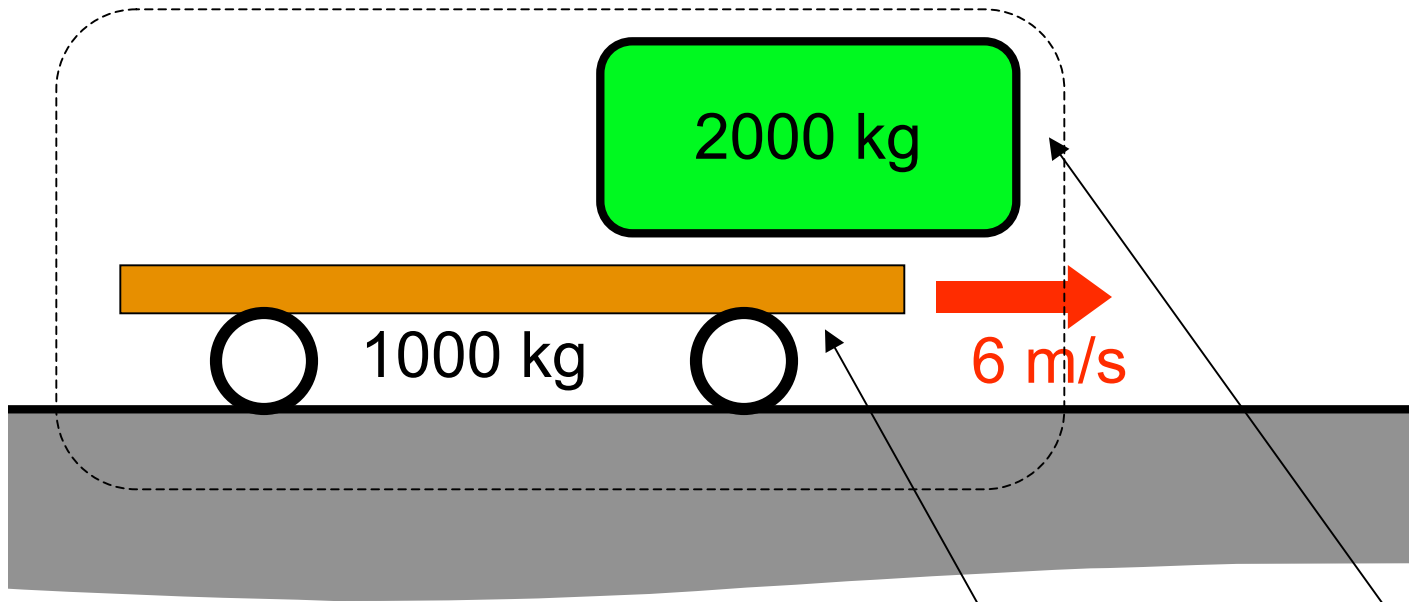

What is  $K_i$  for the railcar/container system?

A  $K_i = 6 \text{ kJ}$

**B  $K_i = 18 \text{ kJ}$**

C  $K_i = 36 \text{ kJ}$

D  $K_i = 54 \text{ kJ}$

$$K_i = 0.5 (1000 \text{ kg}) (6 \text{ m/s})^2 + 0$$

container drops onto it, slides with  $\mu_k = 0.5$

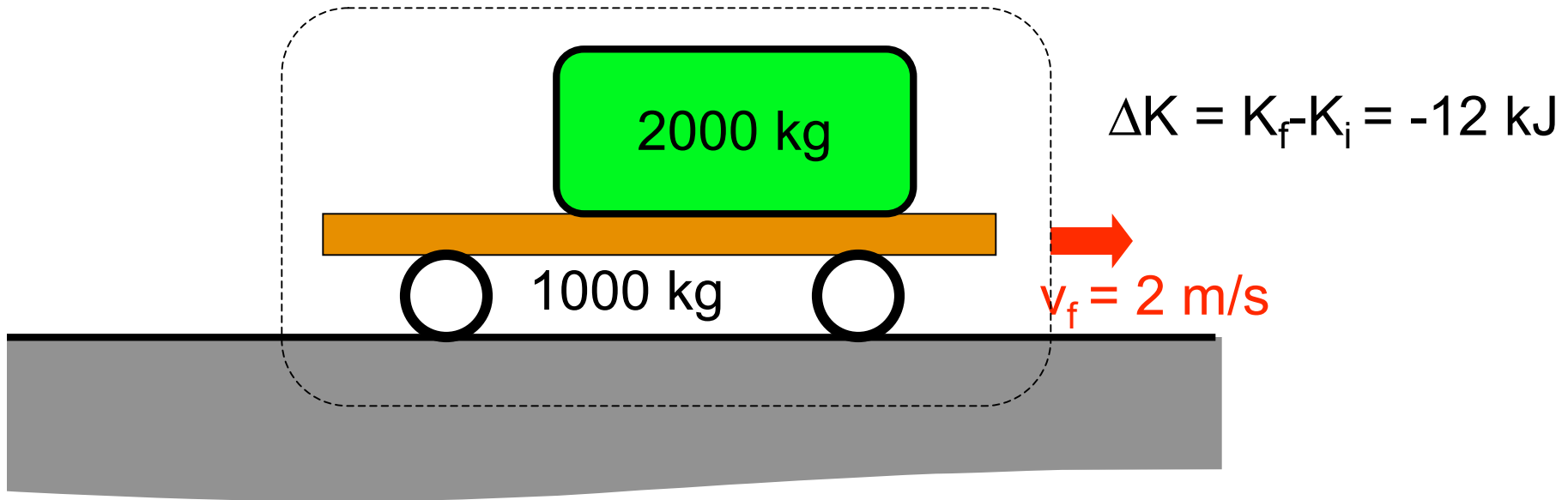

$$K_i = 18 \text{ kJ}$$

What is  $K_f$  for the railcar/container system?

- A  $K_f = 6 \text{ kJ}$
- B  $K_f = 12 \text{ kJ}$
- C  $K_f = 18 \text{ kJ}$
- D  $K_f = 36 \text{ kJ}$

is mechanical energy conserved in the railcar/container system?

# The system view

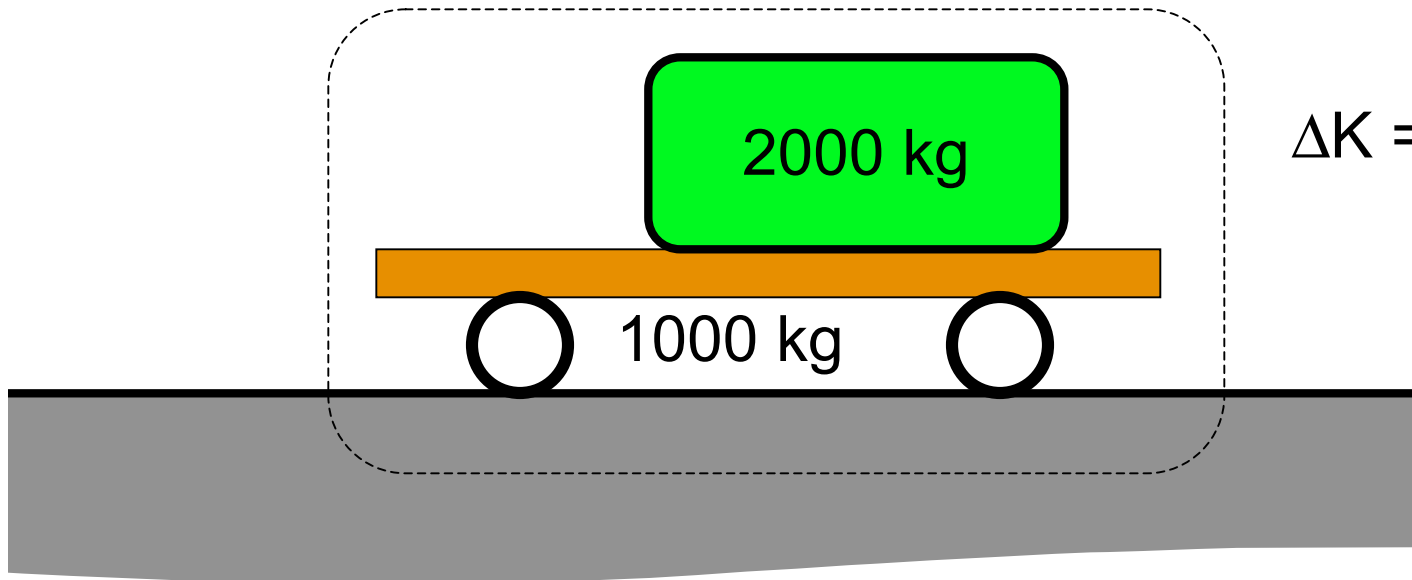

$$\Delta K = K_f - K_i = -12 \text{ kJ}$$

$$W = 0$$

$$\Delta E_{\text{mec}} \neq W$$

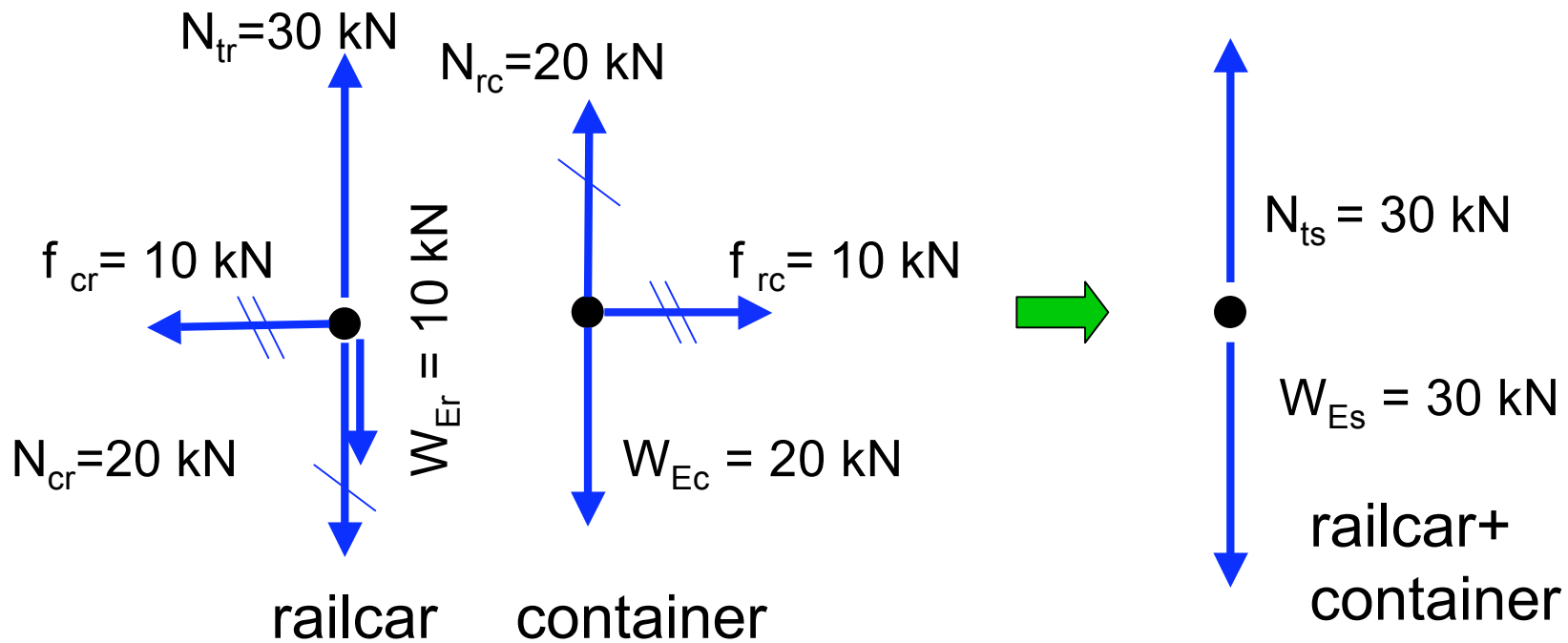

# The particle view (twice)

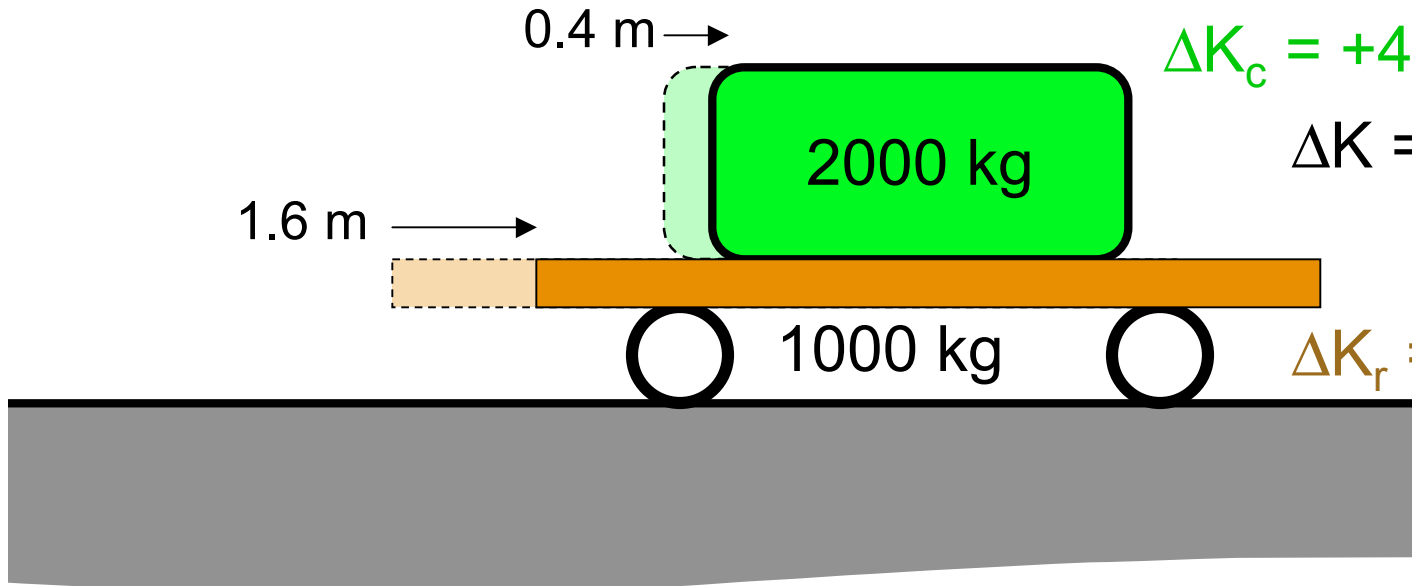

$$\Delta K_c = +4 \text{ kJ}$$

$$\Delta K = K_f - K_i = -12 \text{ kJ}$$

$$\Delta K_r = -16 \text{ kJ}$$

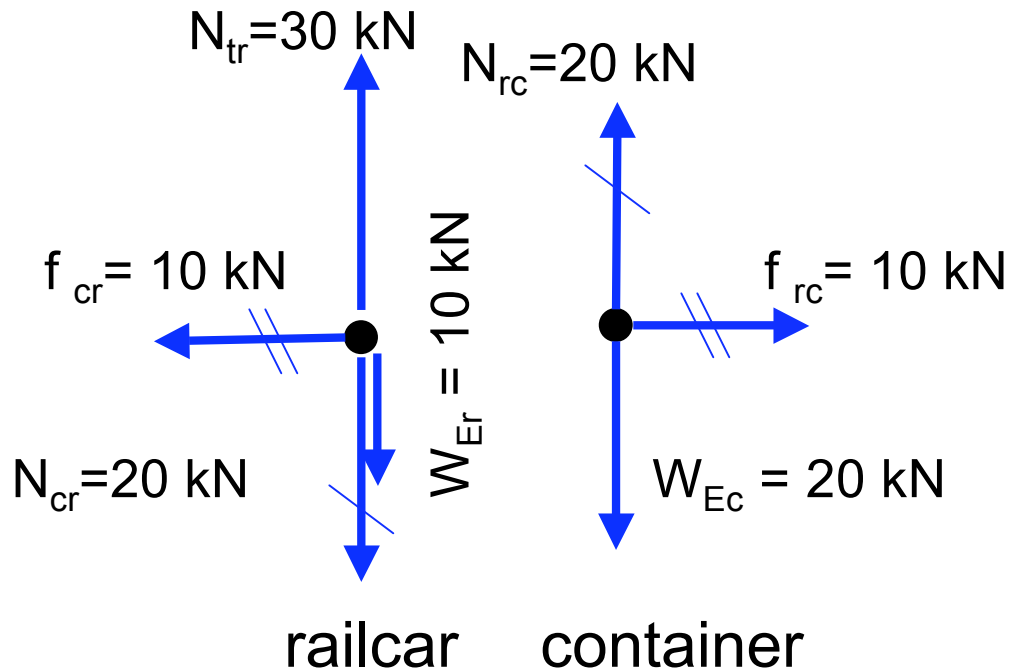

Work done by friction on container:

$$W = (10 \text{ kN})(0.4) = +4 \text{ kJ}$$

Work done by friction on railcar:

$$W = (-10 \text{ kN})(1.6) = -16 \text{ kJ}$$