

Newton's Laws in Circular Motion

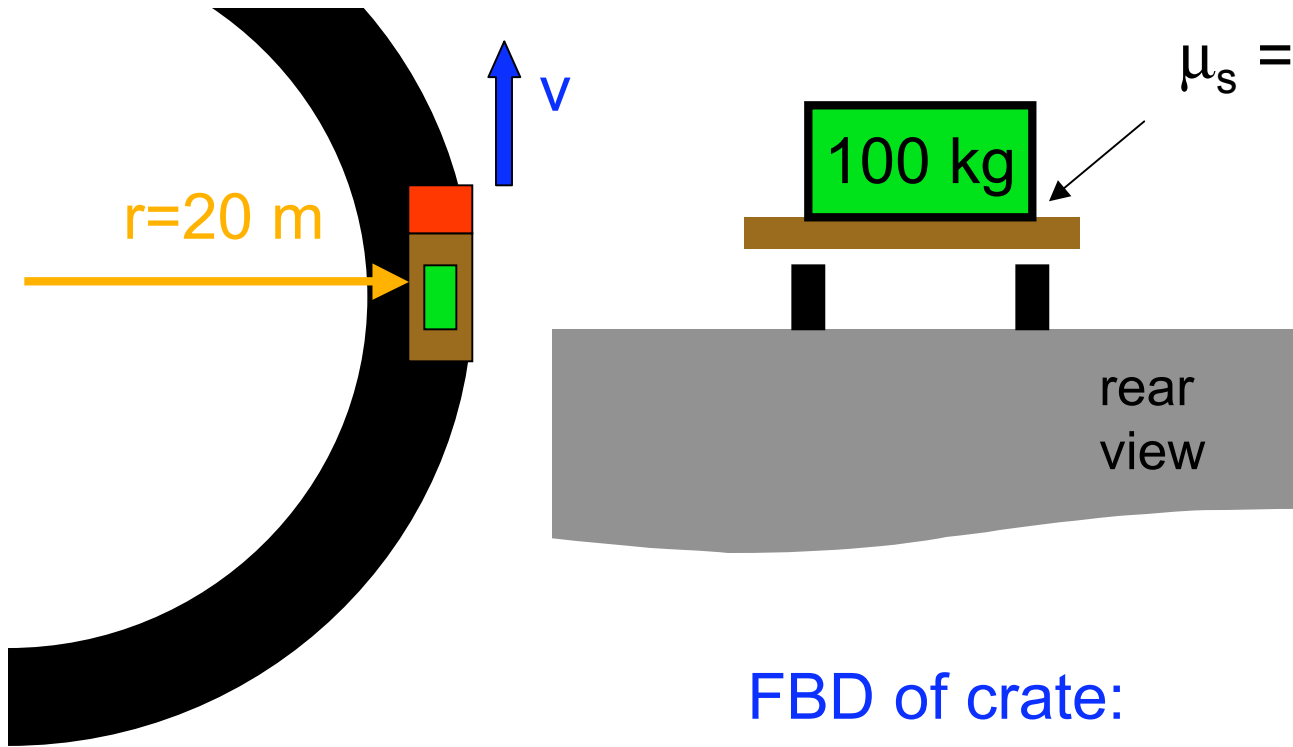



A truck carries a 100 kg crate around a curve. The crate/bed has a coefficient of static friction $\mu_s = 0.5$. How fast can the truck round the corner before the crate slides?

FBD of crate:

A

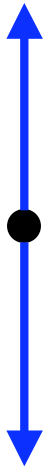

B

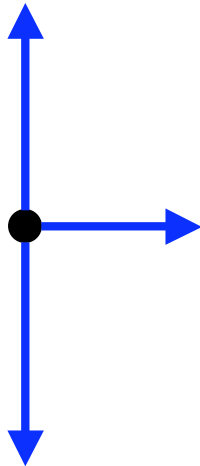

C

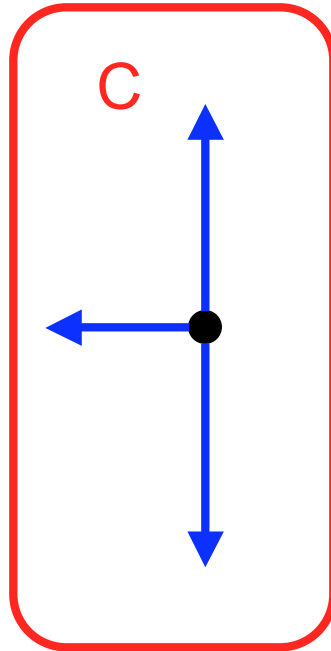

D

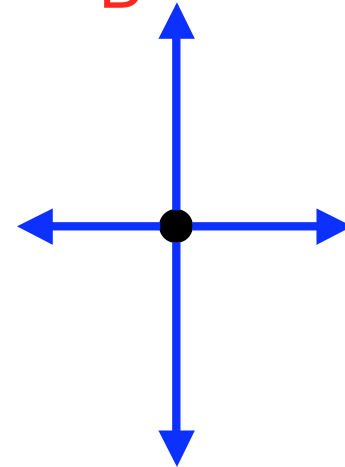

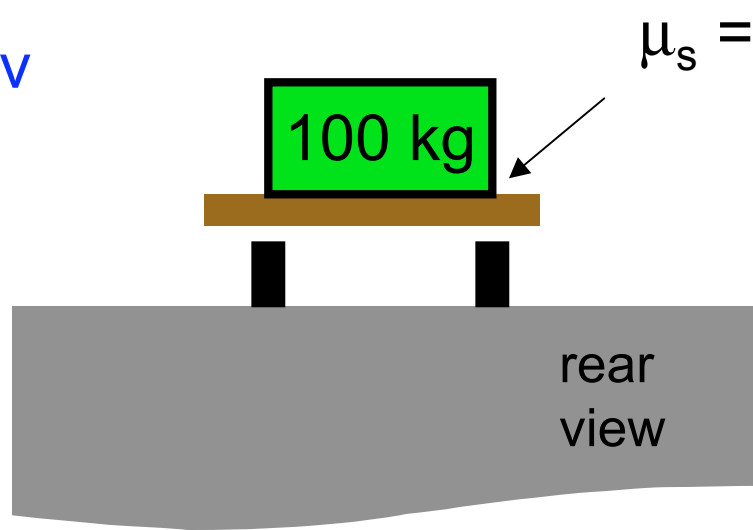
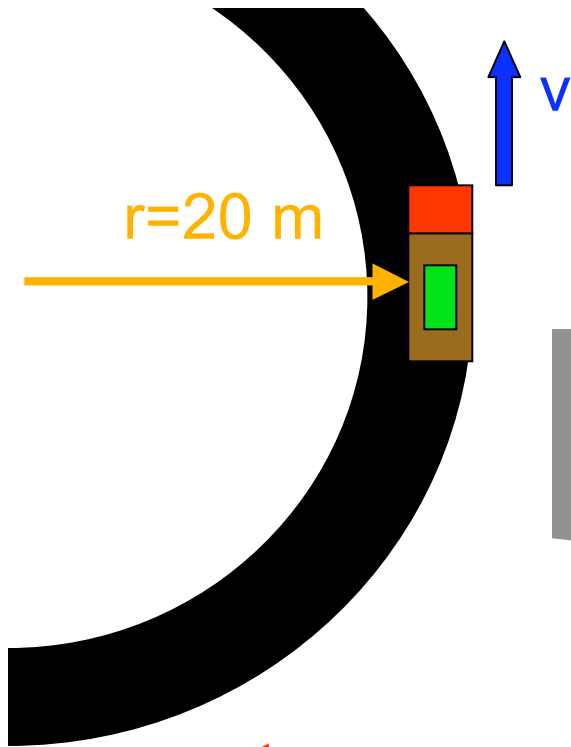

A truck carries a 100 kg crate around a curve. The crate/bed has a coefficient of static friction $\mu_s = 0.5$. How fast can the truck round the corner before the crate slides?

$\leftarrow a = a_c = v^2/r$

$$f_{tc} = M_c v^2/r$$

$$f_{\max} = M_c (v_{\max})^2/r = \mu_k M_c g$$

$$v_{\max} = \sqrt{\mu_k g r}$$

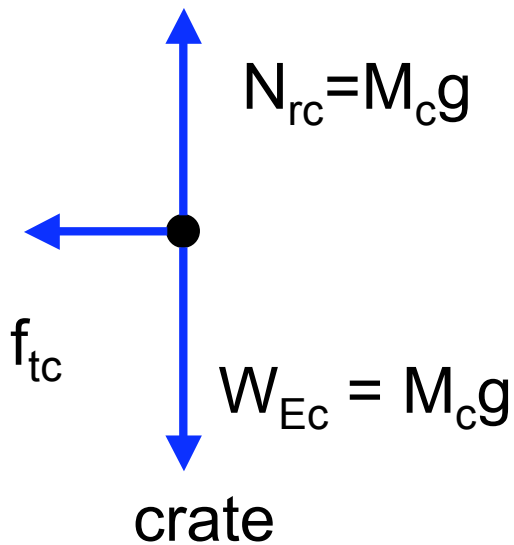

$$v_{\max} = \sqrt{(0.5)(9.8 \text{ m/s}^2)(20 \text{ m})} = 9.9 \text{ m/s}$$

when is the normal force from the chair greater?

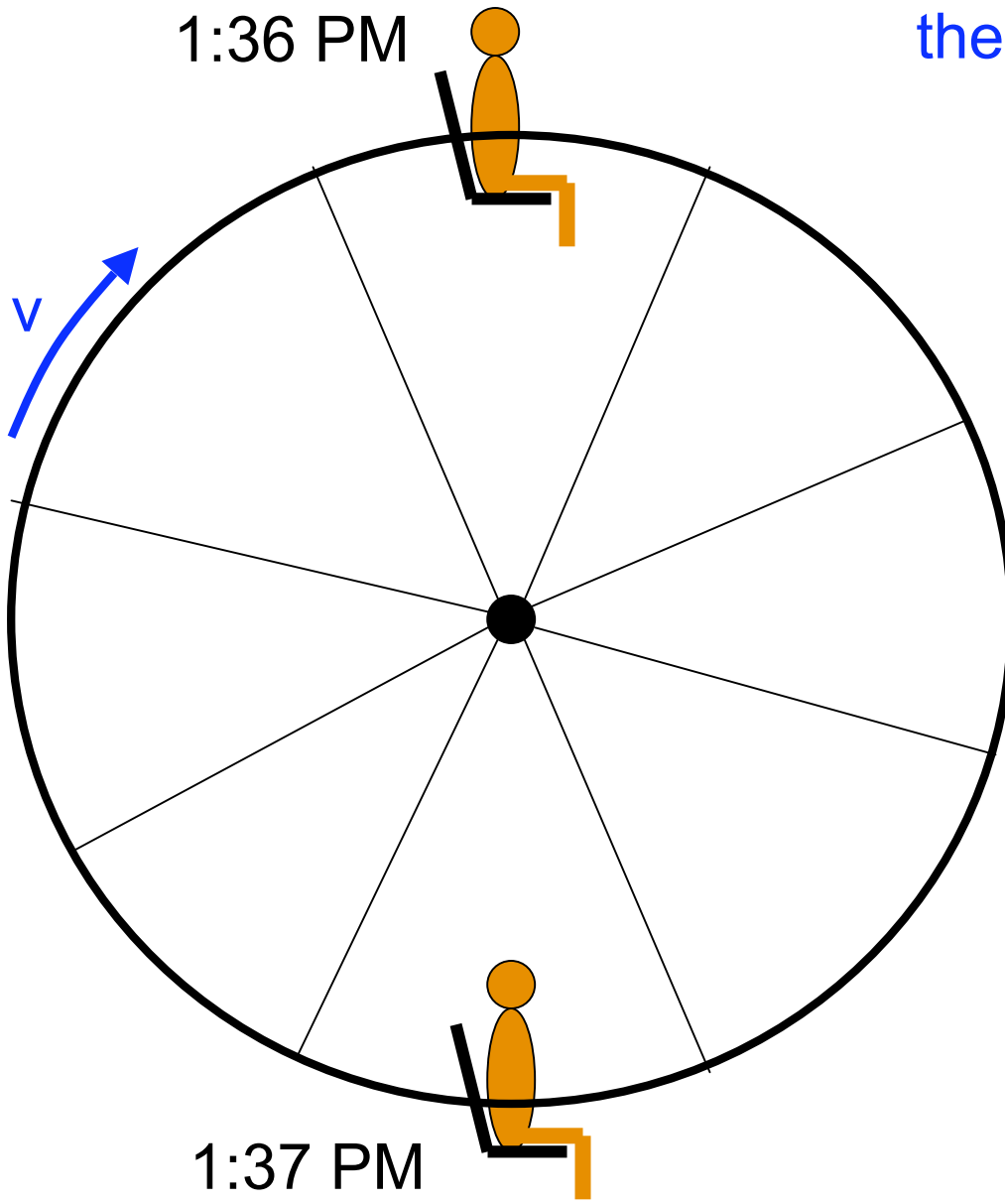

- A 1:36 PM
- B 1:37 PM
- C same
- D need more information

when is the normal force from the chair greater?

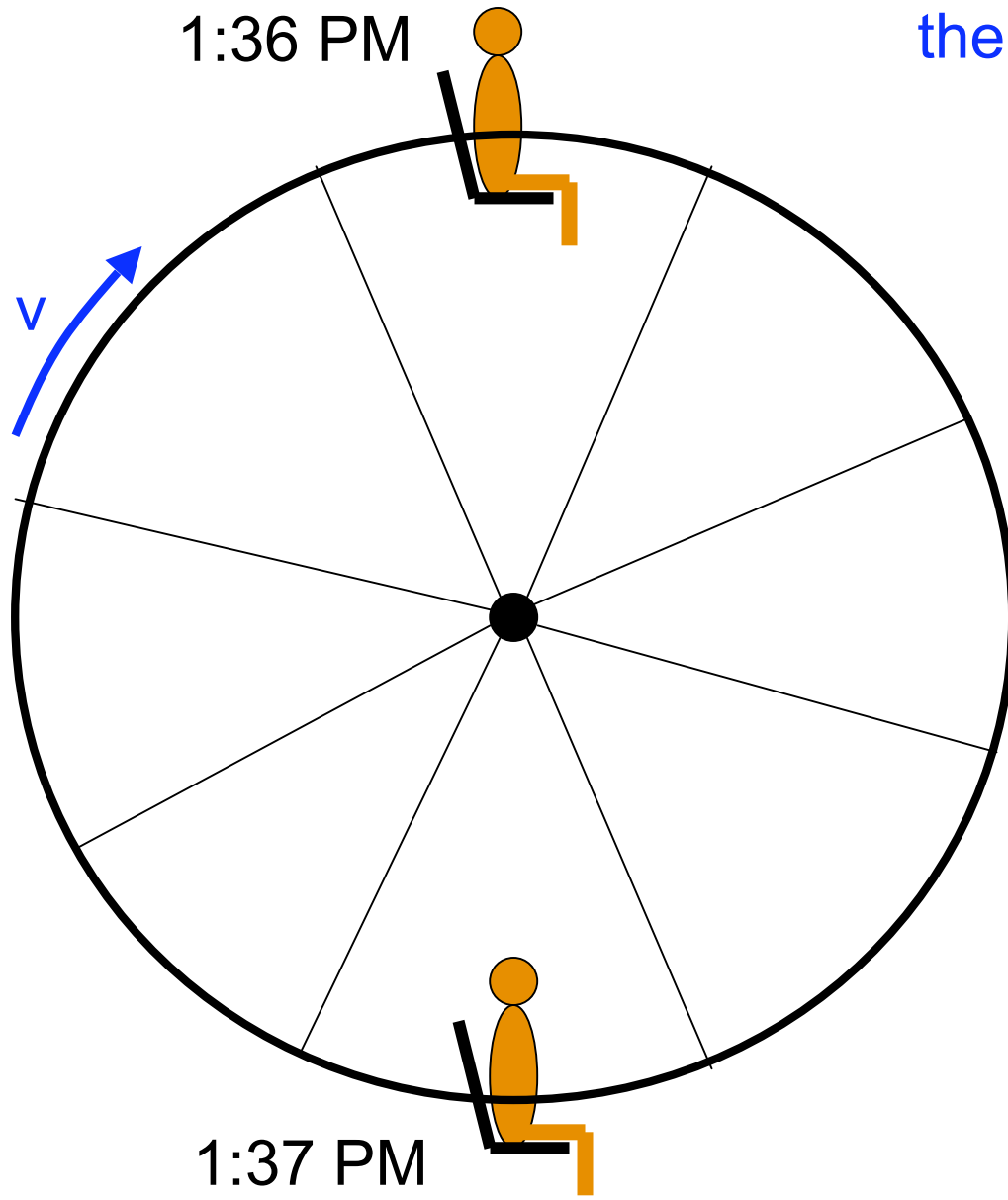

- A 1:36 PM
- B 1:37 PM**
- C same
- D need more information

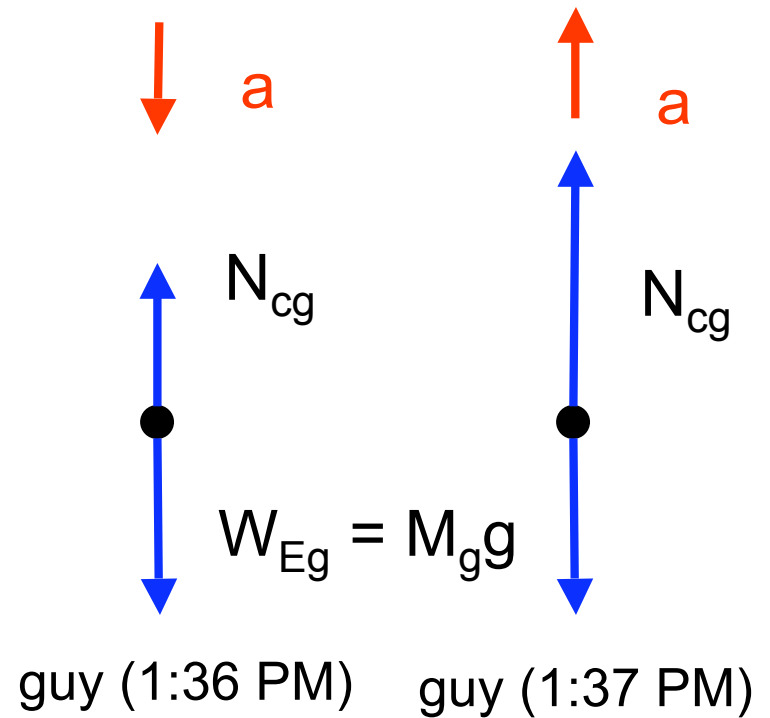

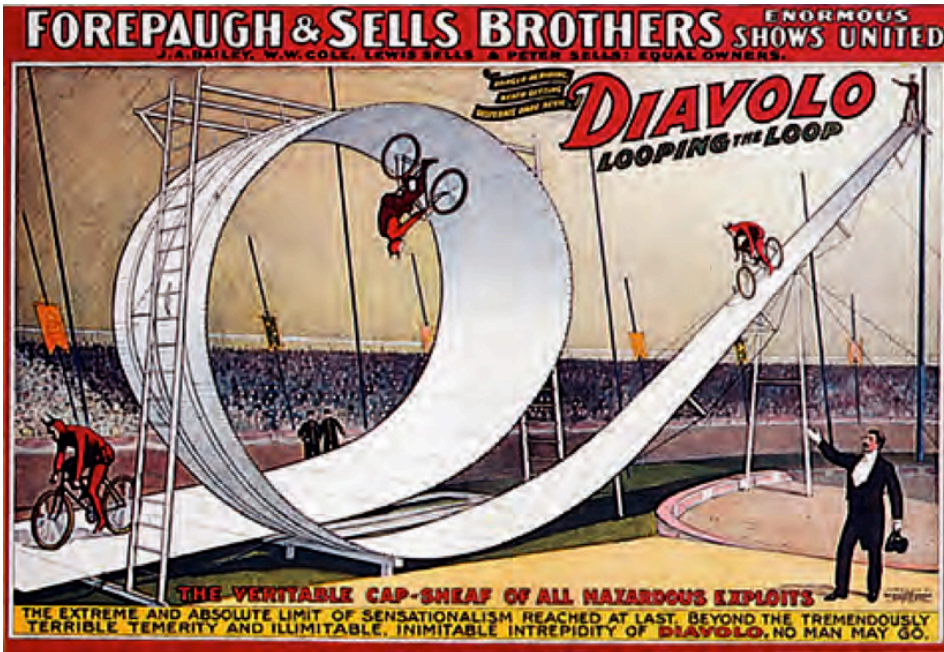

(a)

Diavolo

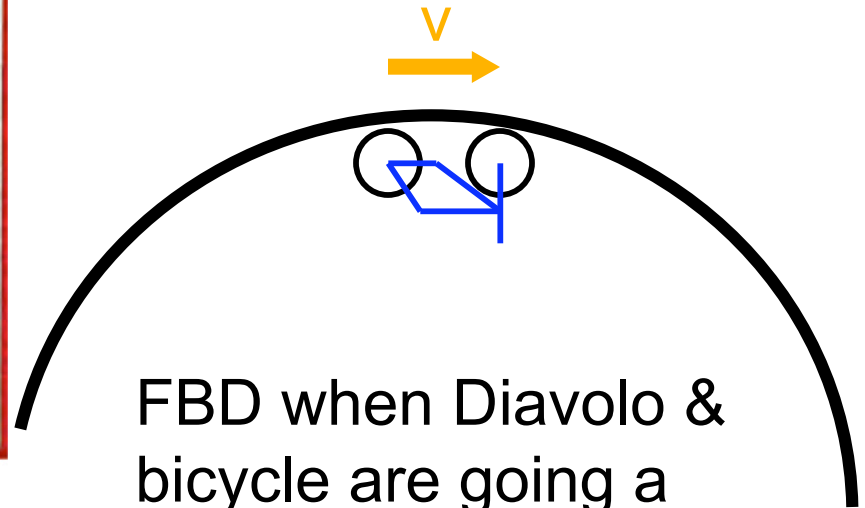

FBD when Diavolo & bicycle are going a little bit faster than then minimum speed

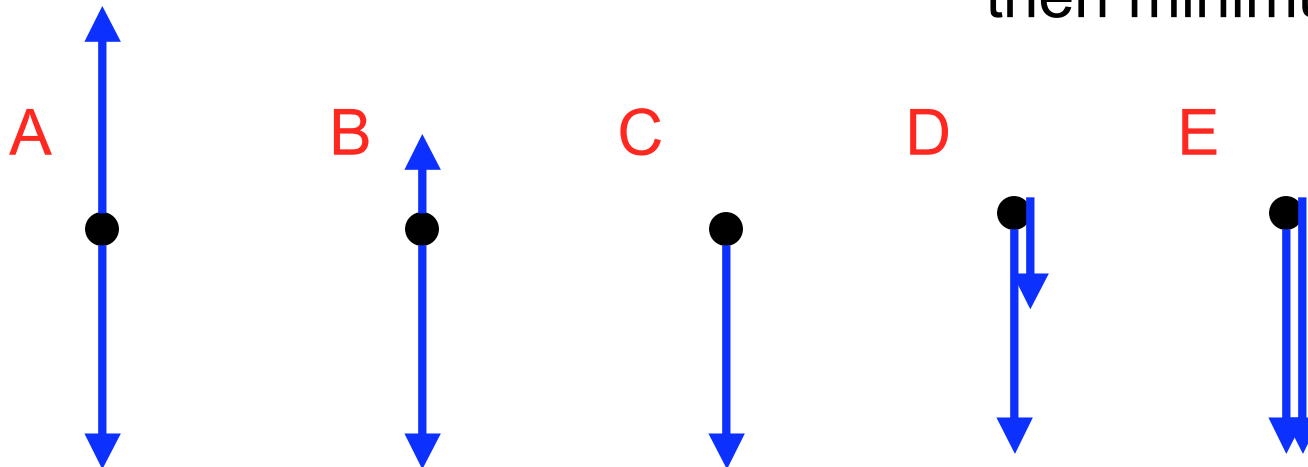

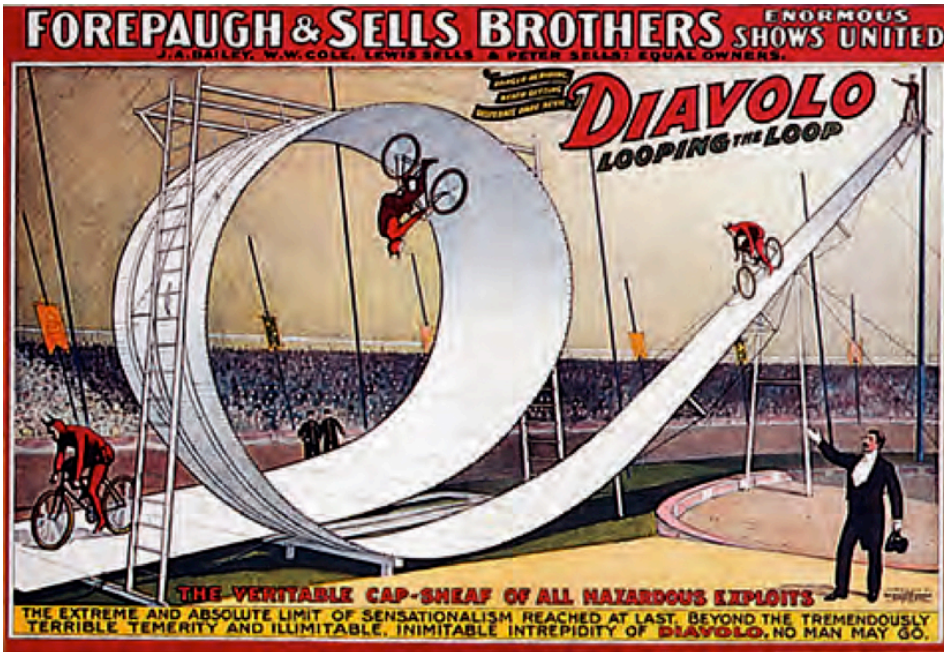

(a)

Diavolo

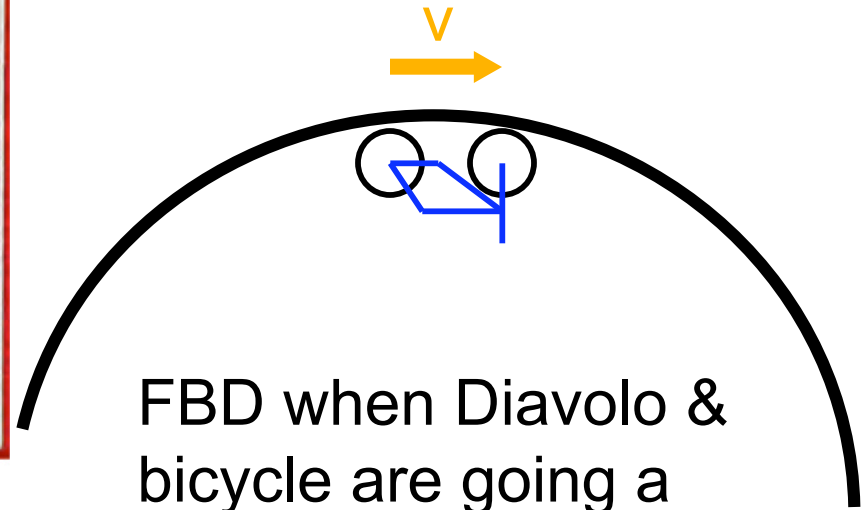

FBD when Diavolo & bicycle are going a little bit faster than then minimum speed

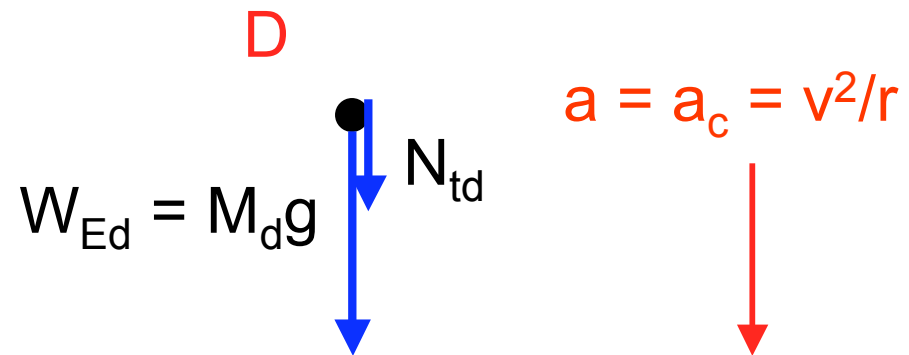

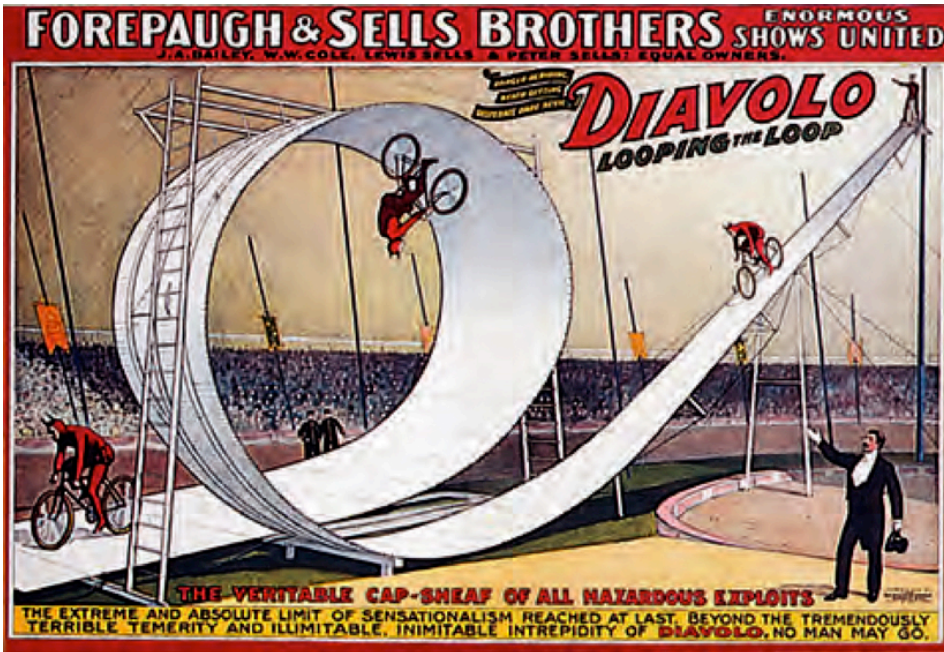

(a)

Diavolo

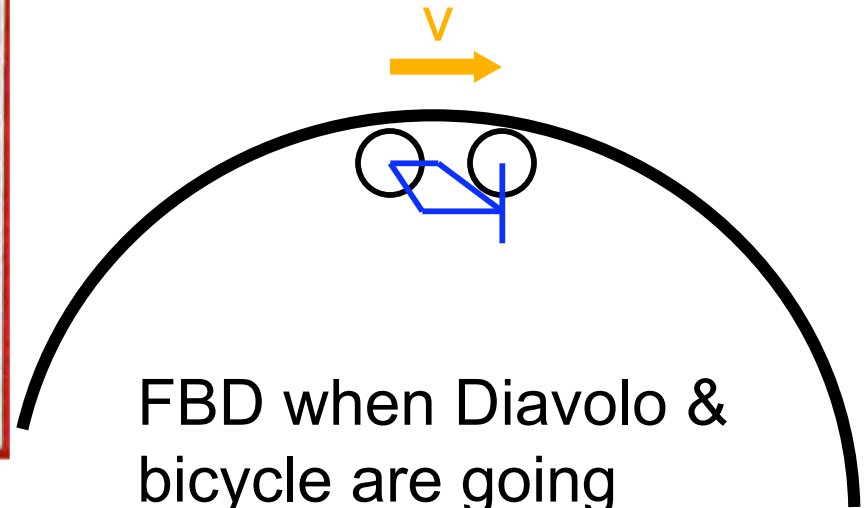

FBD when Diavolo & bicycle are going **exactly** the minimum speed

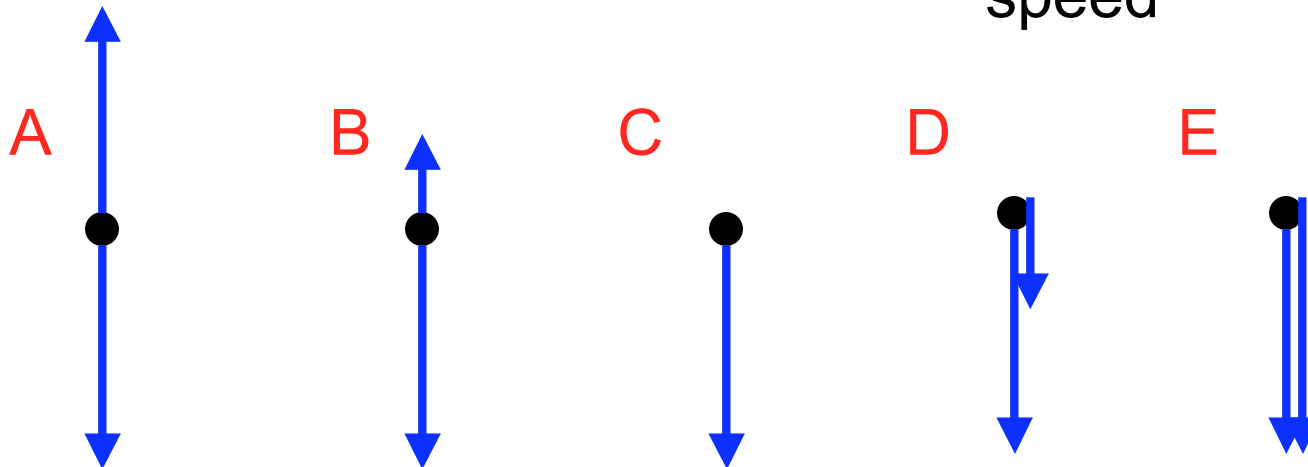

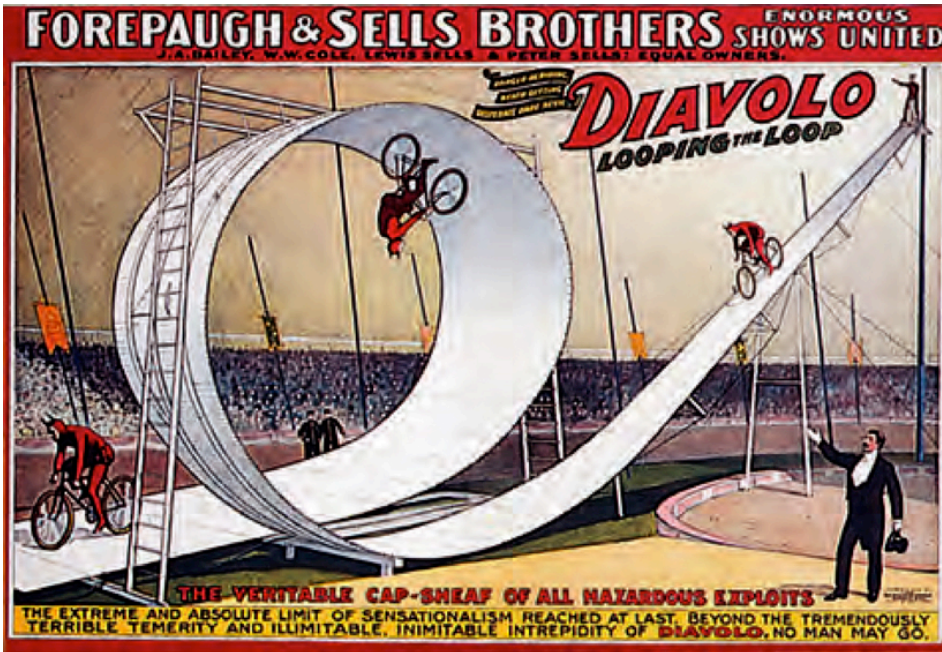

(a)

Diavolo

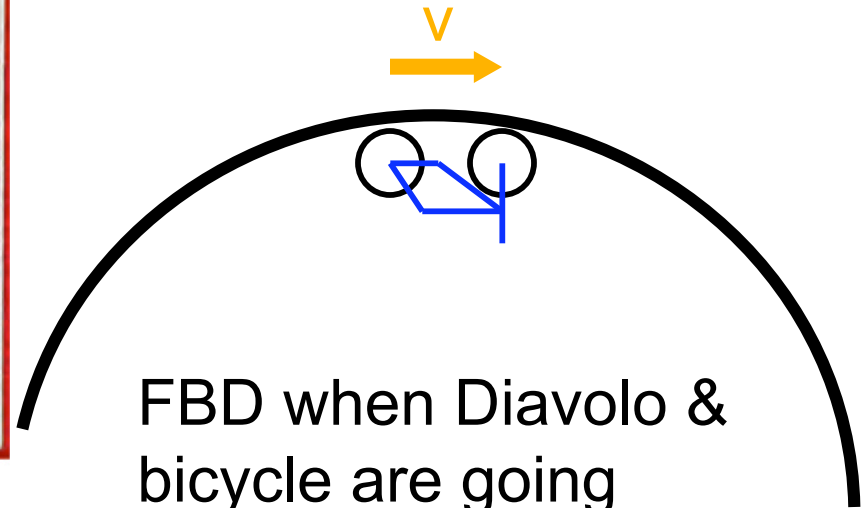

FBD when Diavolo & bicycle are going **exactly** the minimum speed

C

$$W_{Ed} = M_d g$$

$$a = a_c = v^2/r$$

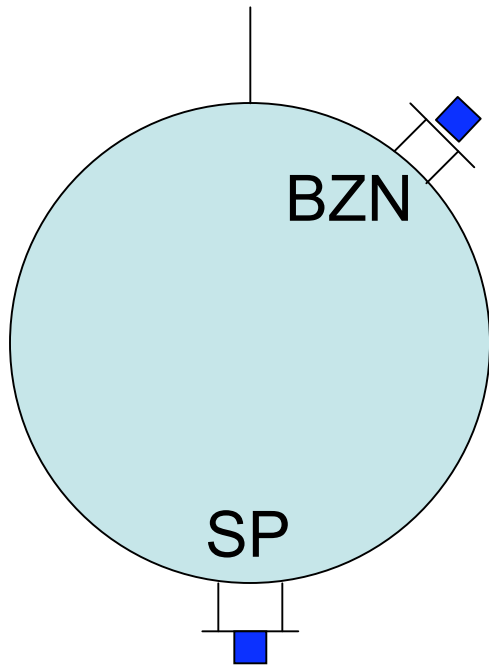

Before leaving Bozeman, John Priscu calibrates his very sensitive scale to read exactly 100.0000 grams for a 100.0000 gram test mass. He takes the scale to the South Pole, then places the same test mass on it. Assuming g is exactly the same in both places (no variation from e.g. altitude) & the scale registers the NORMAL FORCE it must apply to the mass on it.

Hint: in Bozeman the scale would have also supplied static friction directed **NORTHWARD**

- A** The scale reads **HIGHER**
- B** The scale reads **LOWER**
- C** The scale reads **THE SAME**
- D** There is no way to know

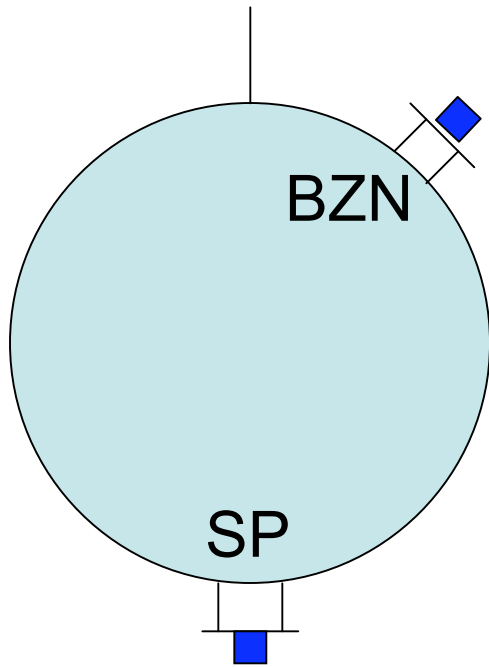

Before leaving Bozeman, John Priscu calibrates his very sensitive scale to read exactly 100.0000 grams for a 100.0000 gram test mass. He takes the scale to the South Pole, then places the same test mass on it. Assuming g is exactly the same in both places (no variation from e.g. altitude) & the scale registers the NORMAL FORCE it must apply.

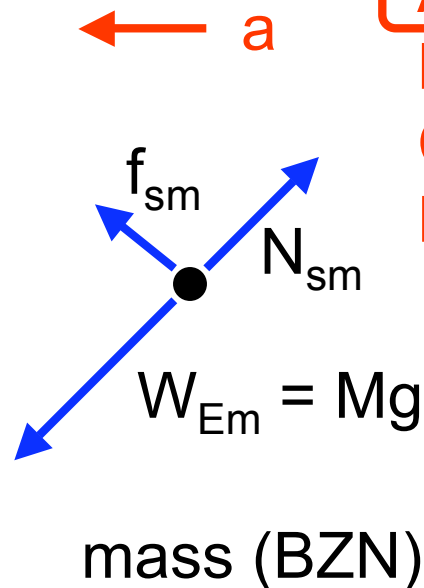
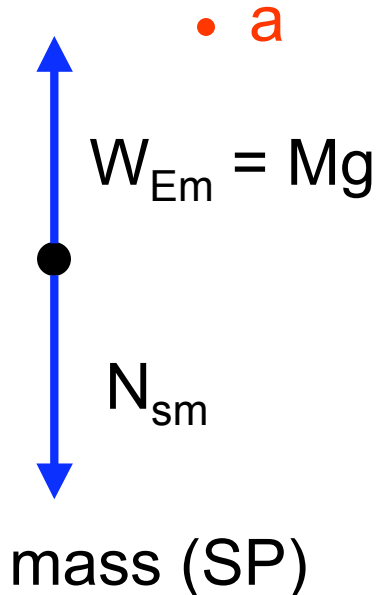

A The scale reads **HIGHER**

B The scale reads **LOWER**

C The scale reads **THE SAME**

D There is no way to know

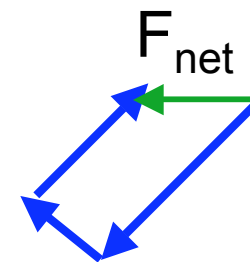

A refreshing, 2 mm
raindrop falls from the sky
at its terminal speed.
What speed is that?



$$m = 4 \times 10^{-6} \text{ kg}$$

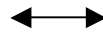

2 mm

FBD of drop:

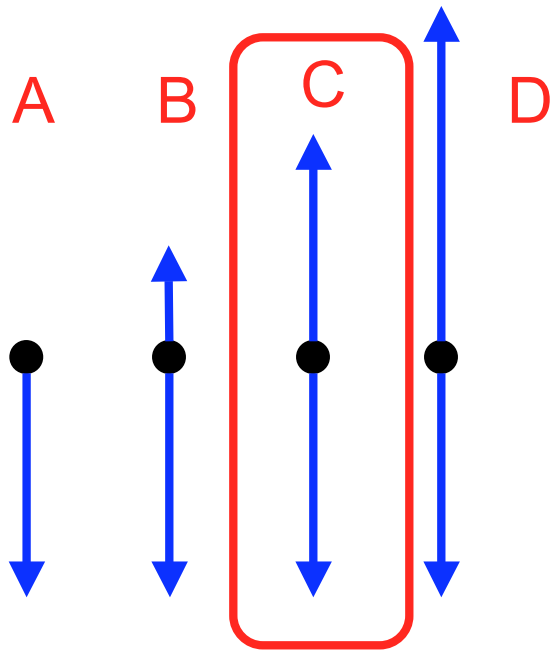

A refreshing, 2 mm
raindrop falls from the sky
at its terminal speed.
What speed is that?

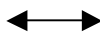

$$m = 4 \times 10^{-6} \text{ kg}$$

2 mm

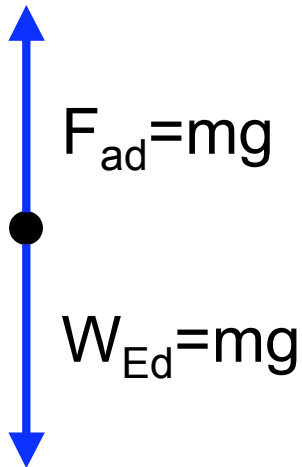

$$F_d = \frac{1}{2} C_d \rho A v^2 = mg$$

$$v = \sqrt{\frac{2mg}{C_d \rho A}} = 4.5 \text{ m/s}$$

A sky diver falls at her terminal speed of 40 m/sec when she opens her 3 m diameter parachute. What force must the parachute cords withstand?

FBD of sky diver:

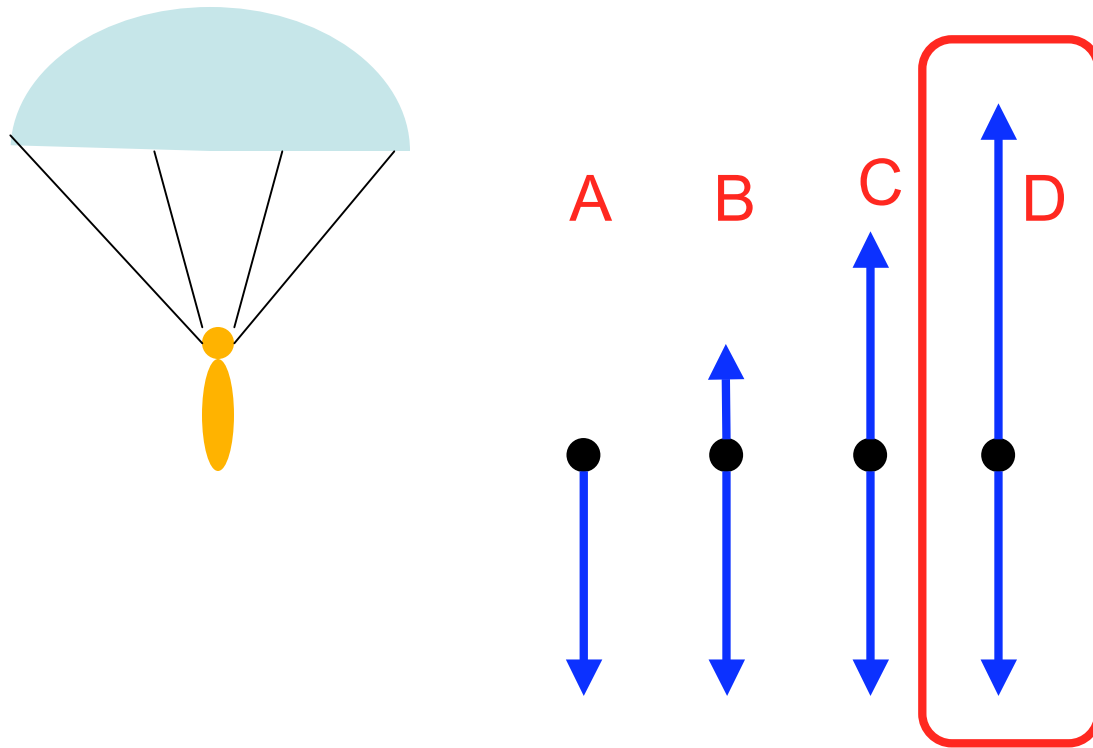

A sky diver falls at her terminal speed of 40 m/sec when she opens her 3 m diameter parachute. What force must the parachute cords withstand?

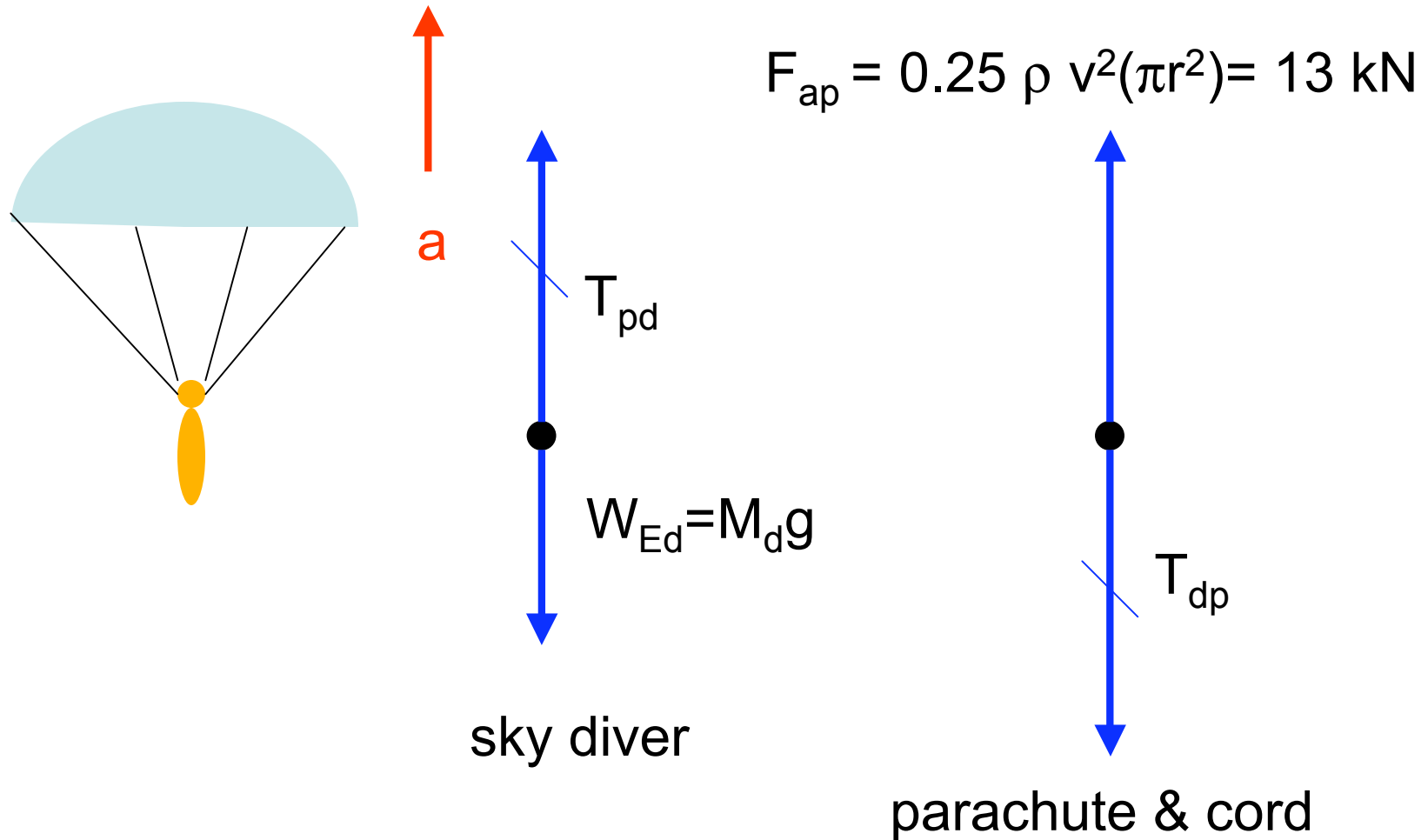

how fast is pendulum circling?

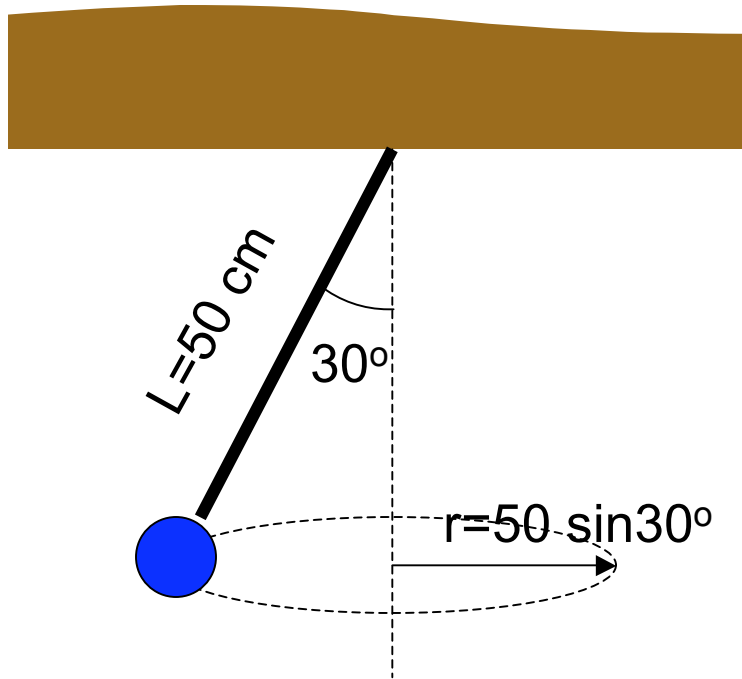

how fast is pendulum circling?

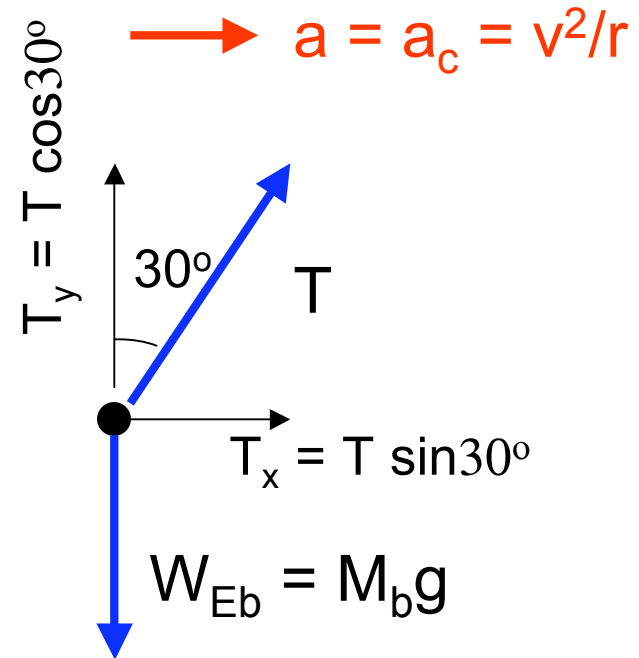
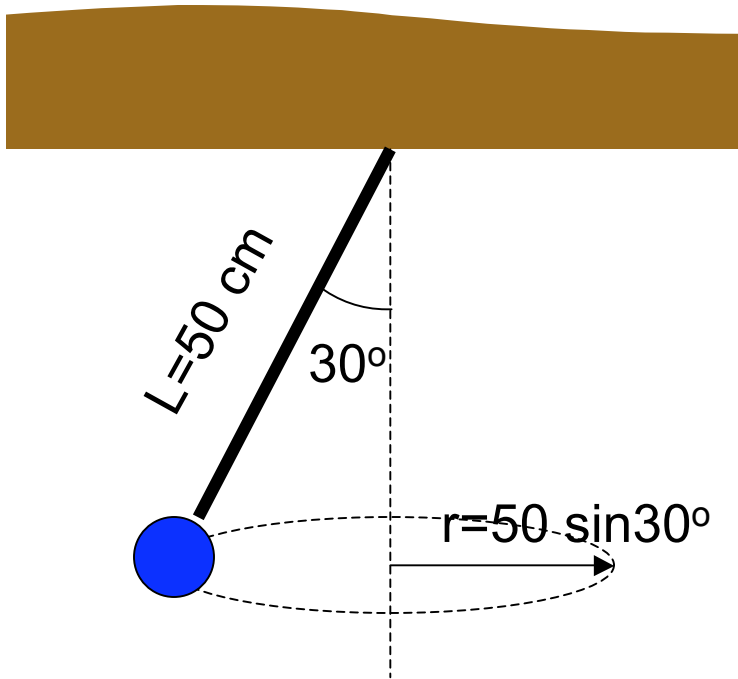

$$y: a_y = 0: T = Mg / \cos 30^\circ$$

$$x: a_c = T_y / M = g \tan 30^\circ$$

$$v = \sqrt{gL \sin 30^\circ \tan 30^\circ} = 1.2 \text{ m/s}$$

Draw FBDs for
Jupiter & Sun

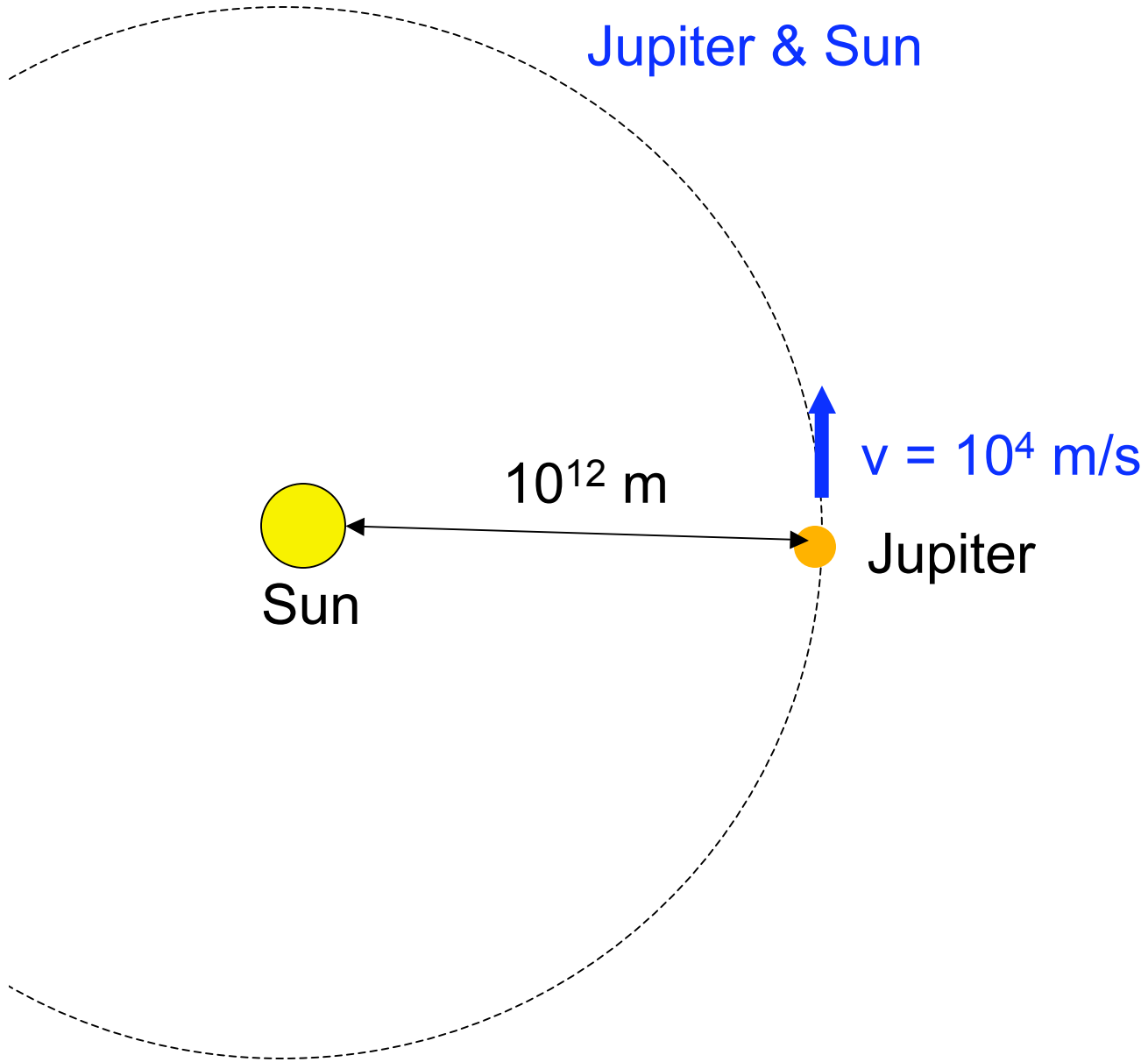

Draw FBDs for
Jupiter & Sun

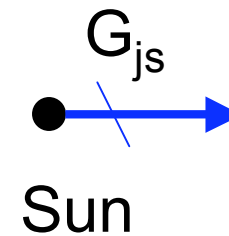
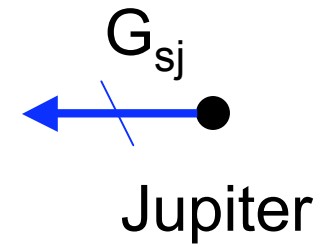
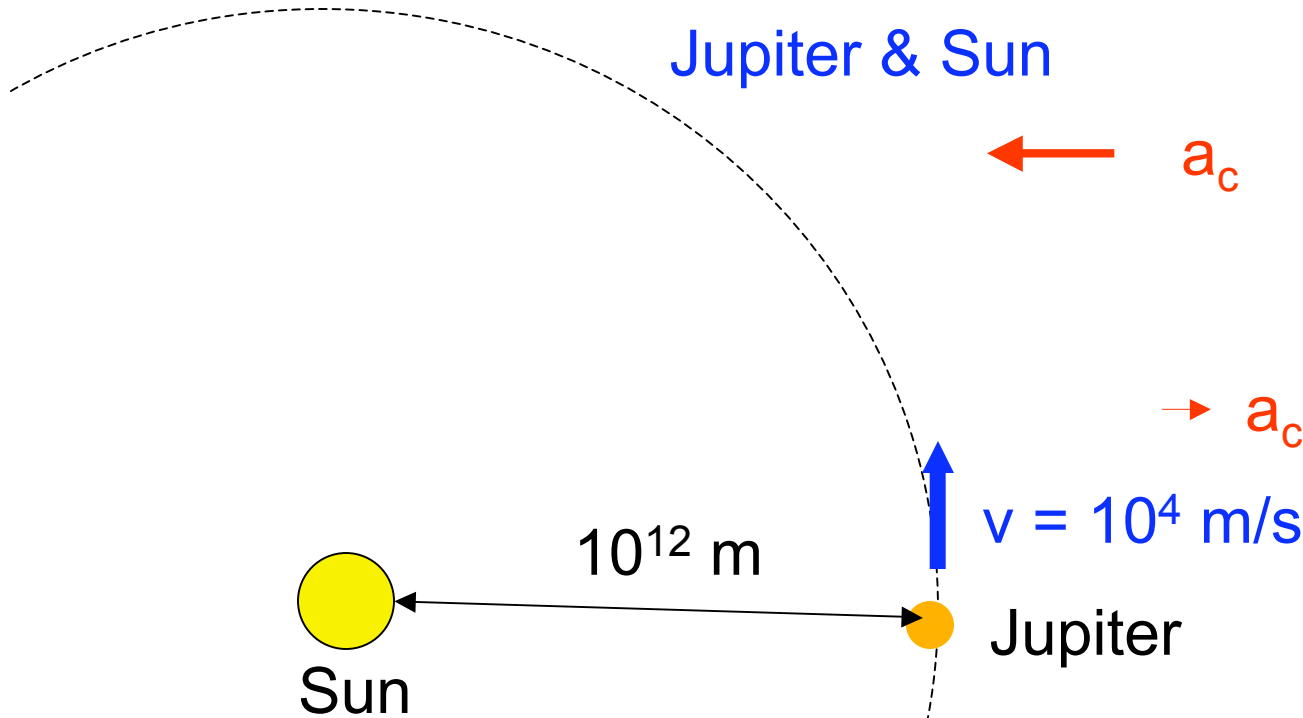

$|a|$ of the SUN is

- A greater than
- B less than**
- C same as
- D is exactly 0

$|a_c|$ of JUPITER

3rd Law

$$M_s a_s = G_{js} = G_{sj} = M_j a_j$$

$$a_s = (M_j / M_s) a_j = 10^{-3} a_j$$

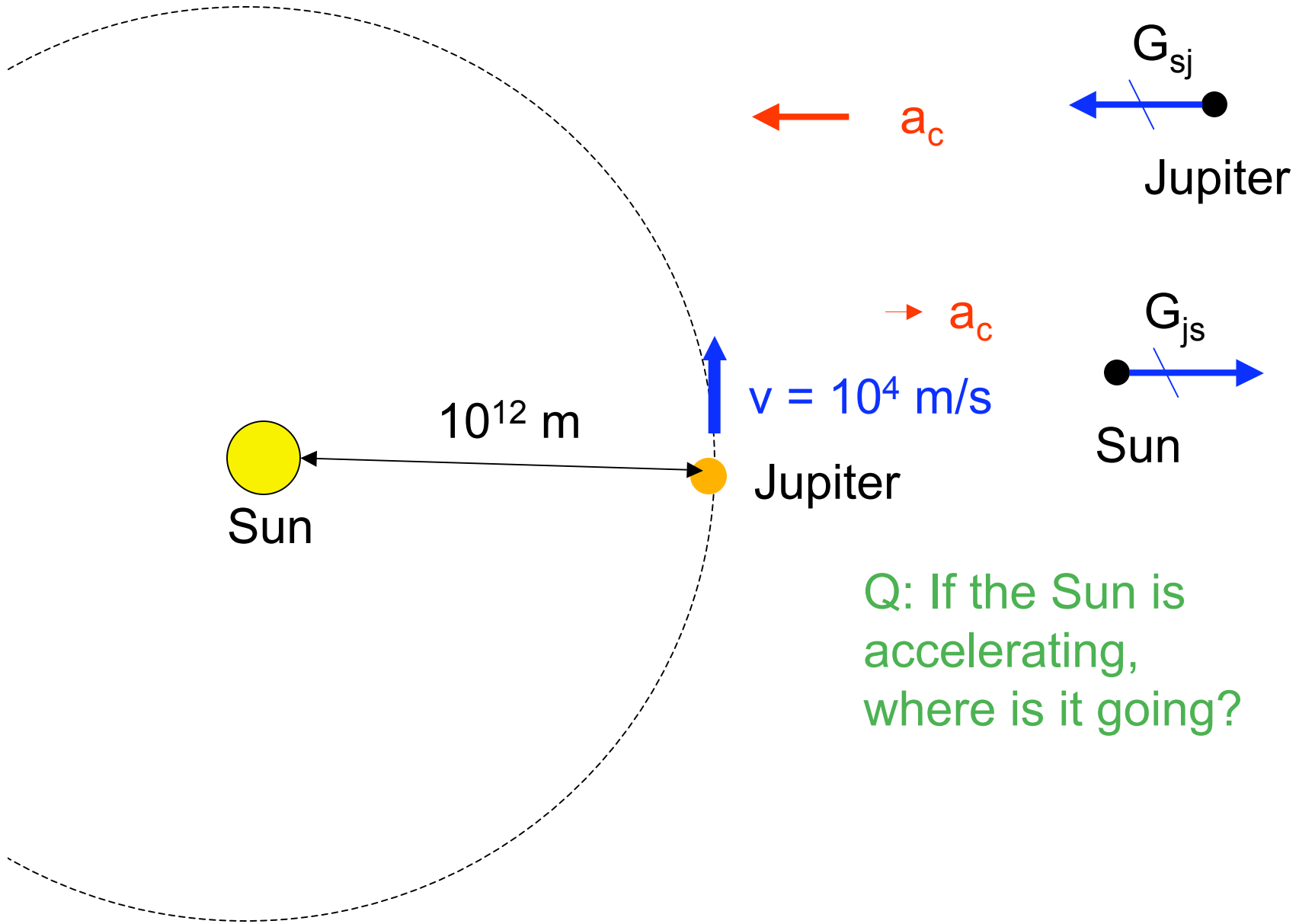

Q: If the Sun is accelerating, where is it going?

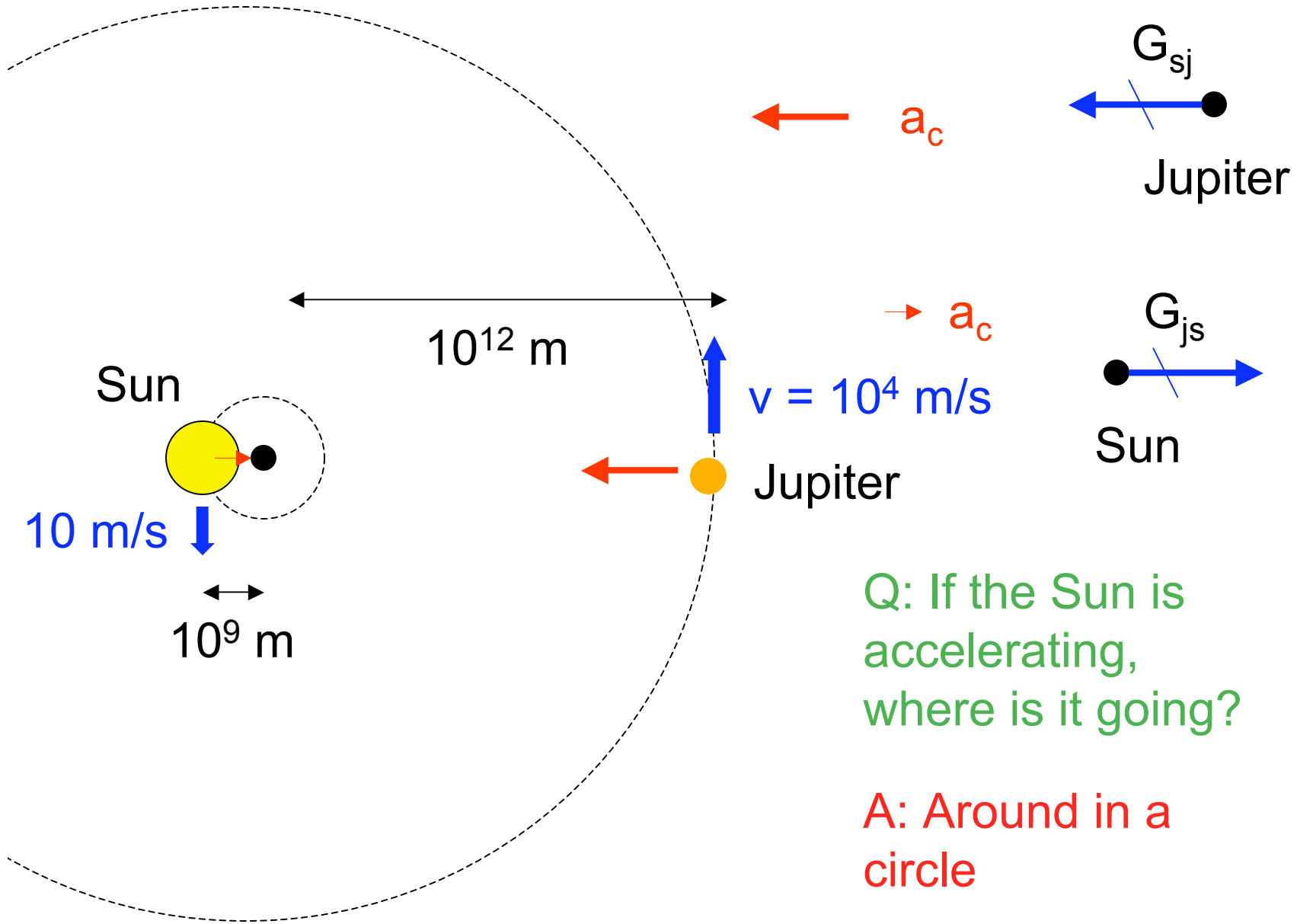

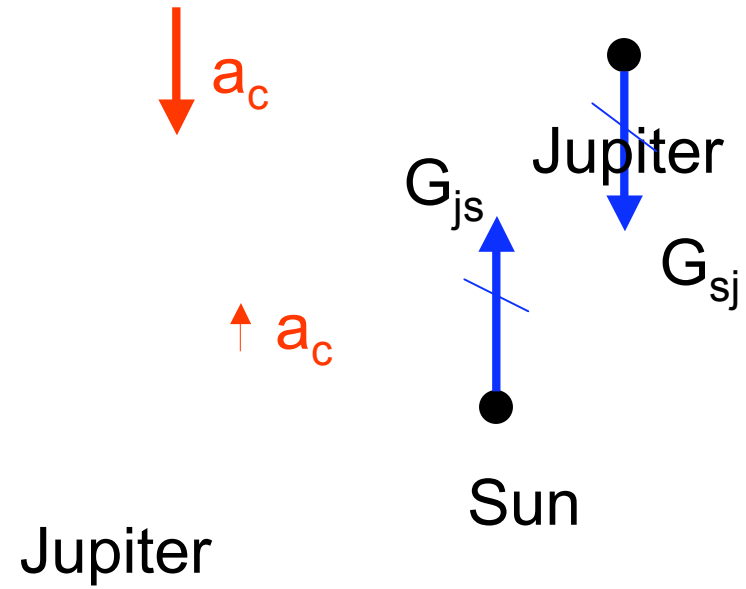
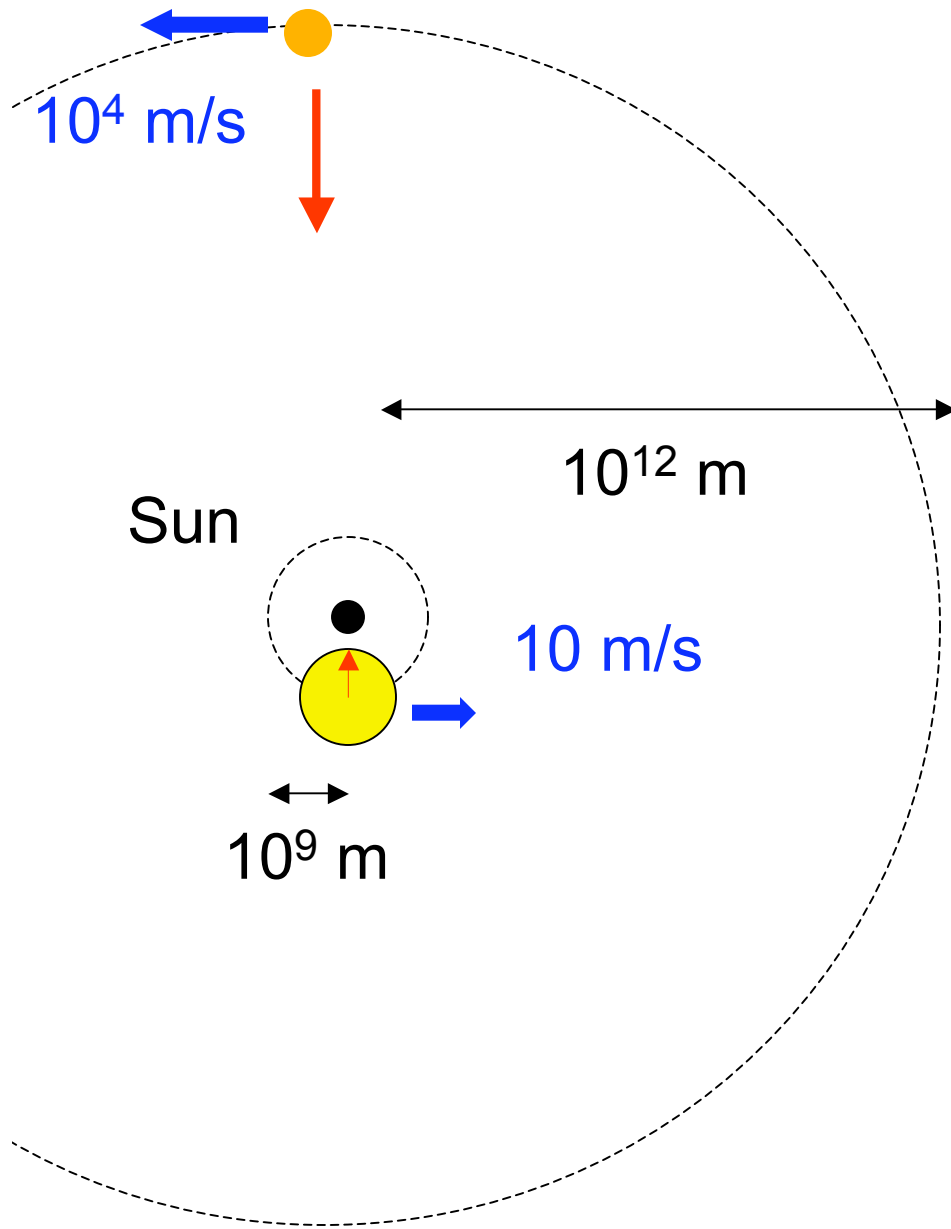

Q: If the Sun is accelerating, where is it going?

A: Around in a circle (once every 11 years)

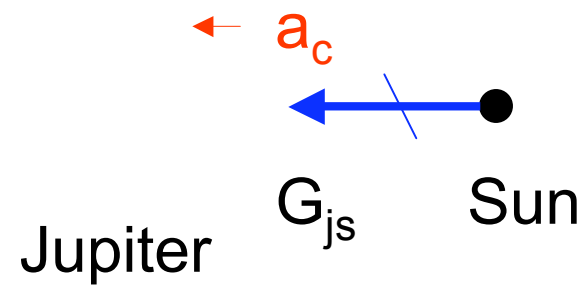
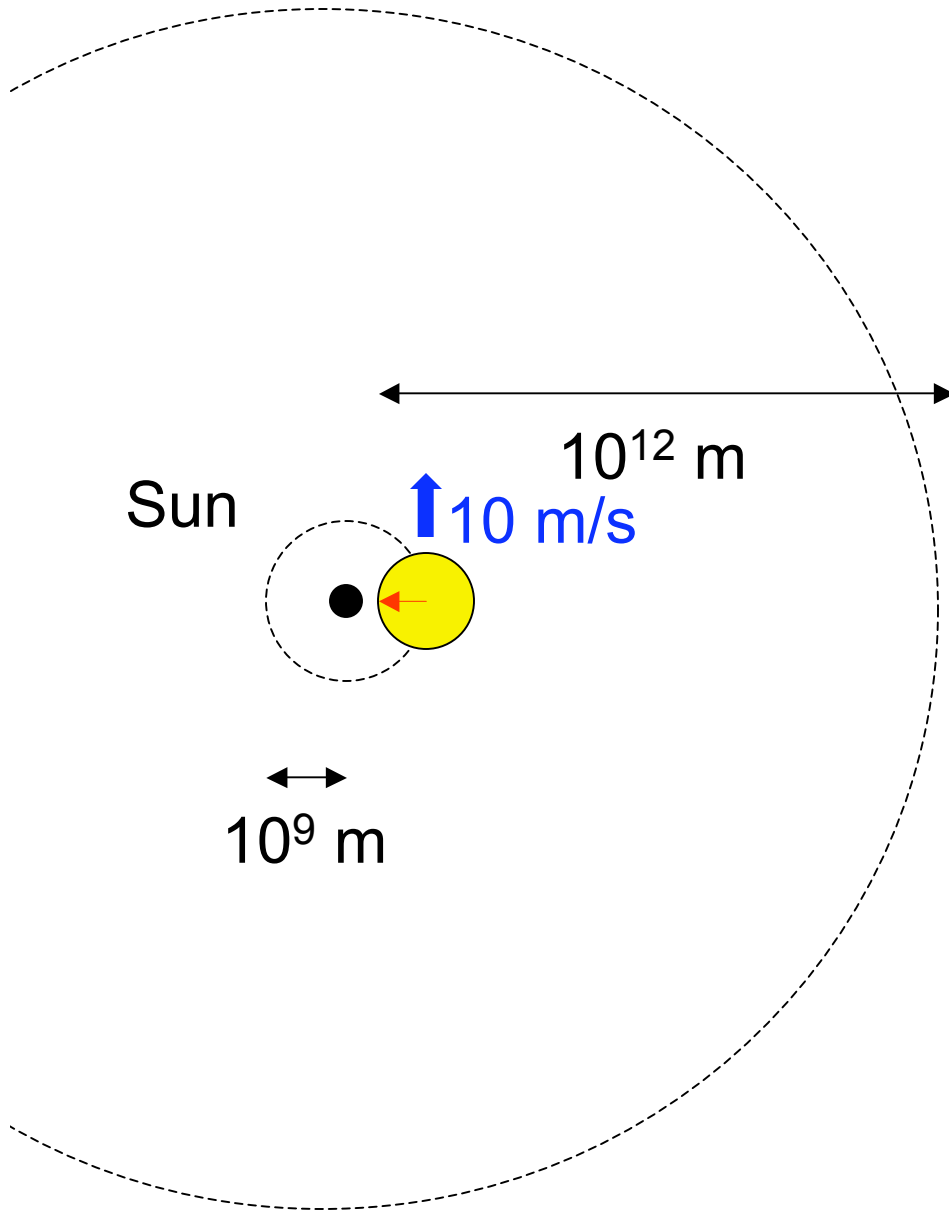

Q: If the Sun is accelerating, where is it going?

A: Around in a circle (once every 11 years)

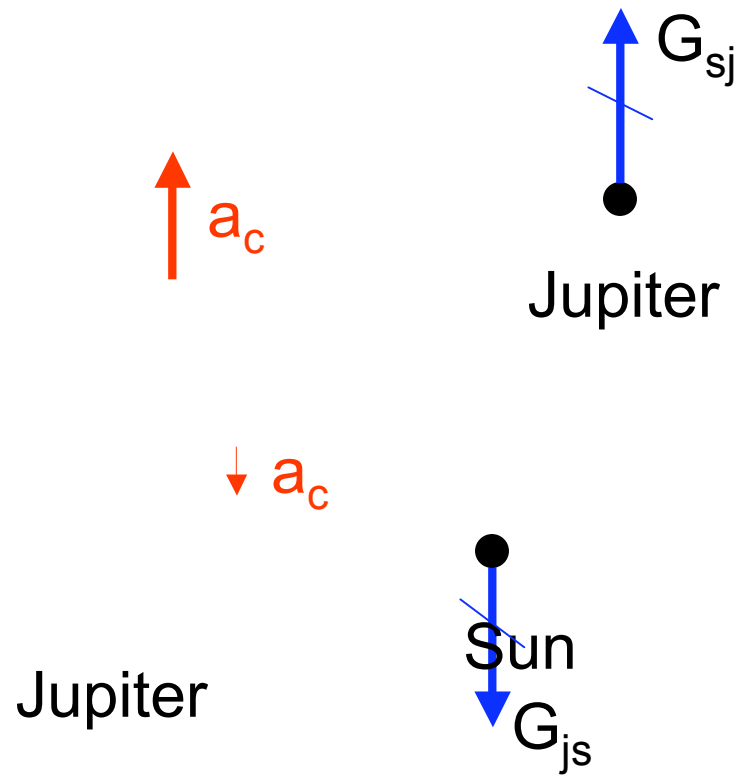
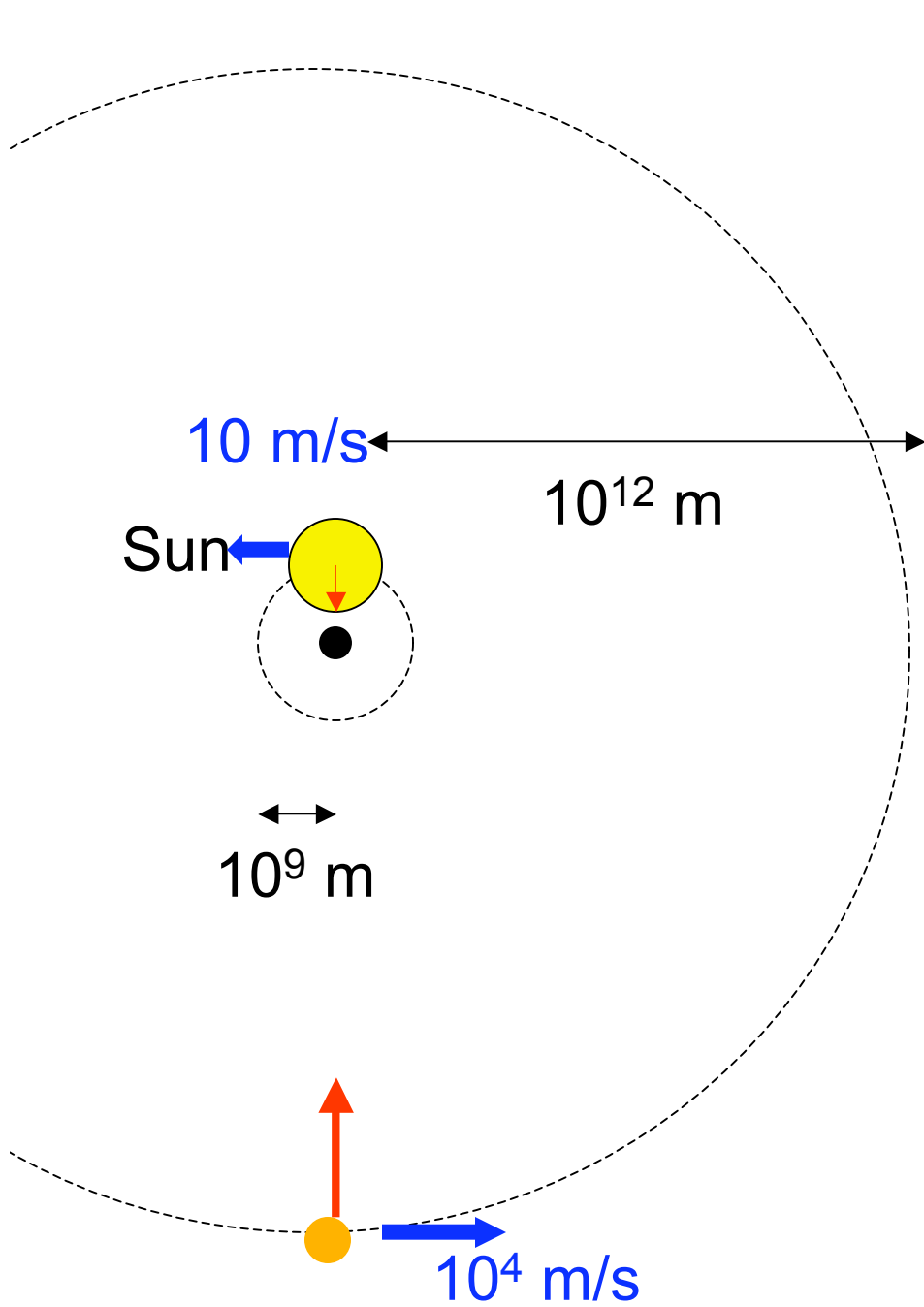

Q: If the Sun is accelerating, where is it going?

A: Around in a circle (once every 11 years)

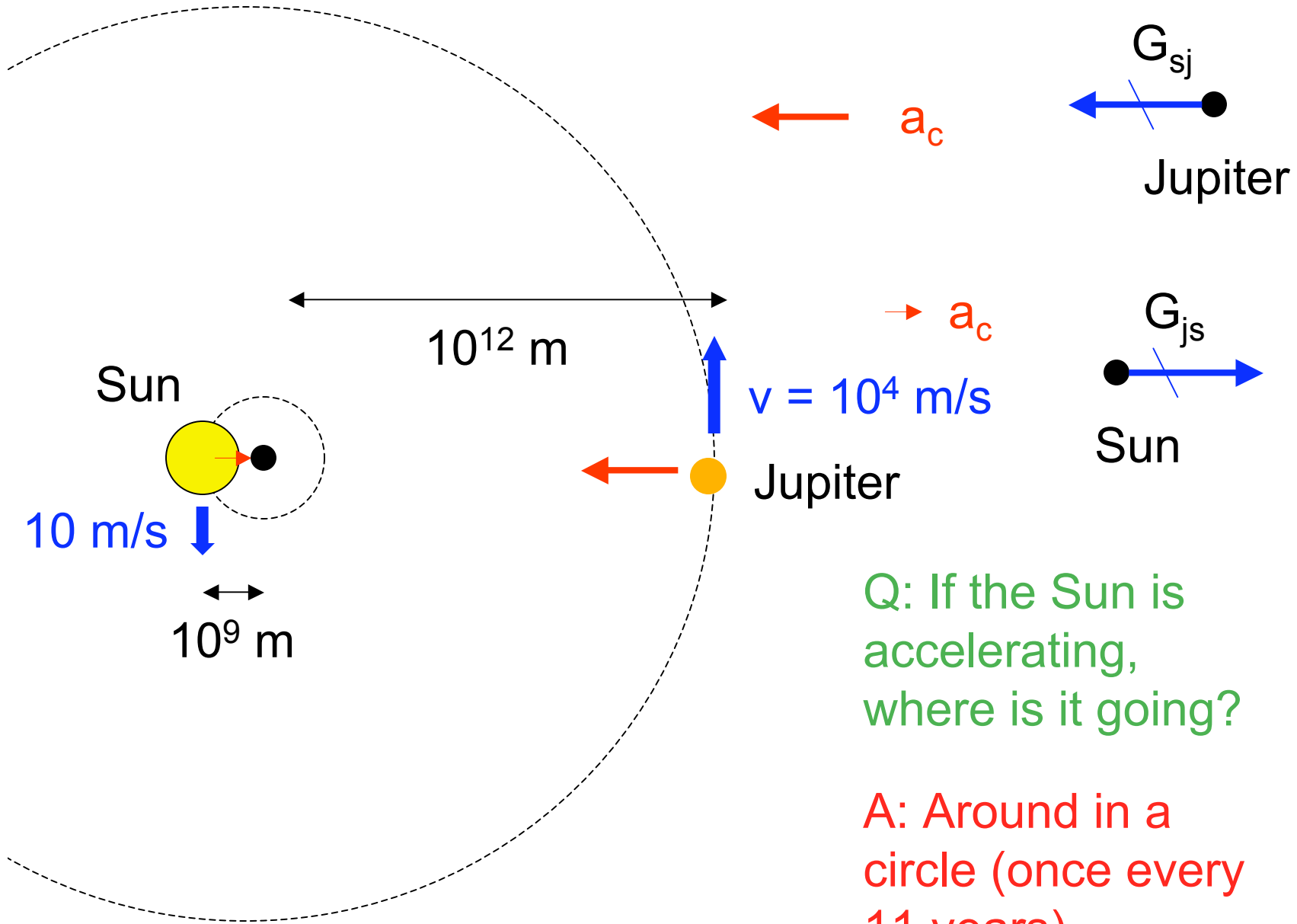

Q: If the Sun is accelerating, where is it going?

A: Around in a circle (once every 11 years)