



Project Progress to Date and Future Work

Montana State University, Department of Physics, 2011 Solar Physics REU

Mike Lerman, Nathan Fite

Advisor: Dr. David Klumpar

Mentors:

Larry Springer, Keith Mashburn, Ehson Mosleh

Overview, Pt. I

- RAMPART CubeSat
- FIREBIRD A/B CubeSats
- POES 17

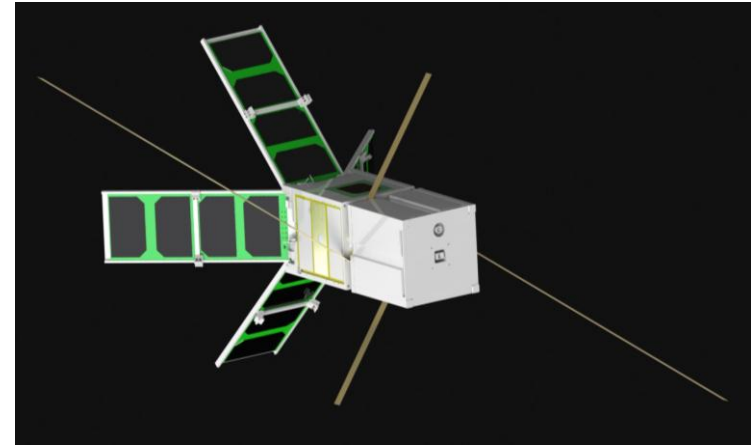

RAMPART



POES 17

(<http://www.scottchurchdirect.com/global-warming.aspx/troposphere-temperature-trends-pt1>)

RAMPART

- Project Began 3Q 2009
- Size: 10cm x 10cm x 22cm
- Weight: 3kg
- Work Completed
 - Solar Panels
 - Structure
- Future Work
 - Antenna System

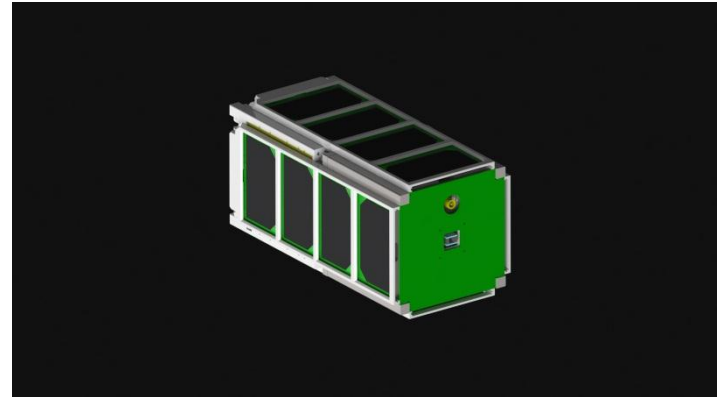

RAMPART Stowed Configuration

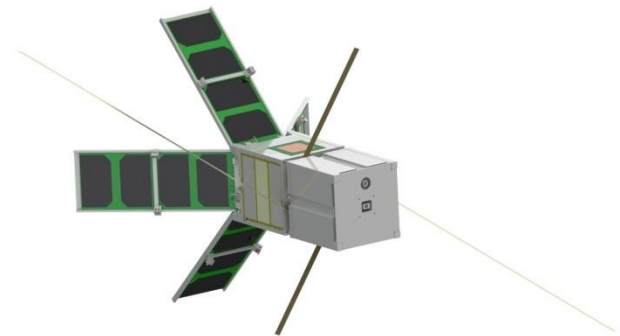

RAMPART Deployed Configuration

FIREBIRD A/B

- Focused Investigations of Relativistic Electron Burst Intensity, Range, and Dynamics
- 2 Satellite Constellation
- Size: 10cm x 10cm x 16cm
- Weight: 2kg
- Built by the MSU SSEL, University of New Hampshire, Aerospace Corporation
- Microburst Electron Precipitation in Radiation Belt Dynamics
 - What is the spatial scale size of an individual burst?
 - What is the energy dependence of an individual burst?
 - How much total electron loss do bursts produce globally
- Future Work
 - FIREBIRD GPS Unit
 - Satellite Separation
 - Antenna Deployment

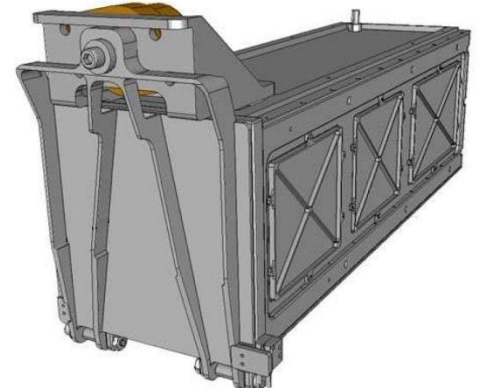

POES 17

- Polar-Orbiting Environmental Satellites
- Size: 4m x 2m
- Weight: 2230kg
- NOAA Satellite
- Spin Stabilized
- Similar Data to EIP, built by MSU SSEL
- Template for EIP Data
- Pertinent Data:
 - 4 Telescopes
 - 2 Electron Telescopes of 3 channels each
 - 2 Proton Telescopes of 6 channels each
 - FoLat (Geo-Magnetic Latitude)
 - Pitch Angles (w/ respect to velocity vector)



POES 17

(<http://www.scottchurchdirect.com/global-warming.aspx/troposphere-temperature-trends-pt1>)

POES 17, cont'd

- Proton Telescopes
 - Telescope 1 Oriented Along Velocity Vector
 - Telescope 2 Oriented 90° from Velocity Vector
- 6 Linear, Circular Silicon Chips per Telescope
- Proton Channels Info
 - Channel 1: 30keV to 80keV
 - Channel 2: 80keV to 240keV
 - Channel 3: 240keV to 800 keV
 - Channel 4: 800keV to 2500keV
 - Channel 5: 2500keV to 6900keV
 - Channel 6: $> 6900\text{keV}$

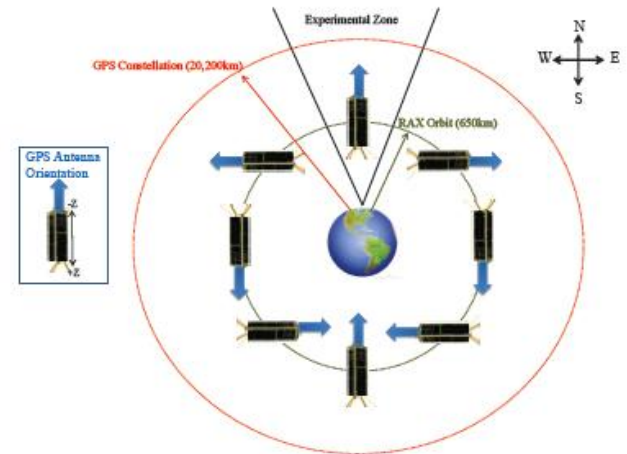

RAX CubeSat
(Courtesy Sara Spangelo,
Michigan University)

Proton Flux vs FoLat

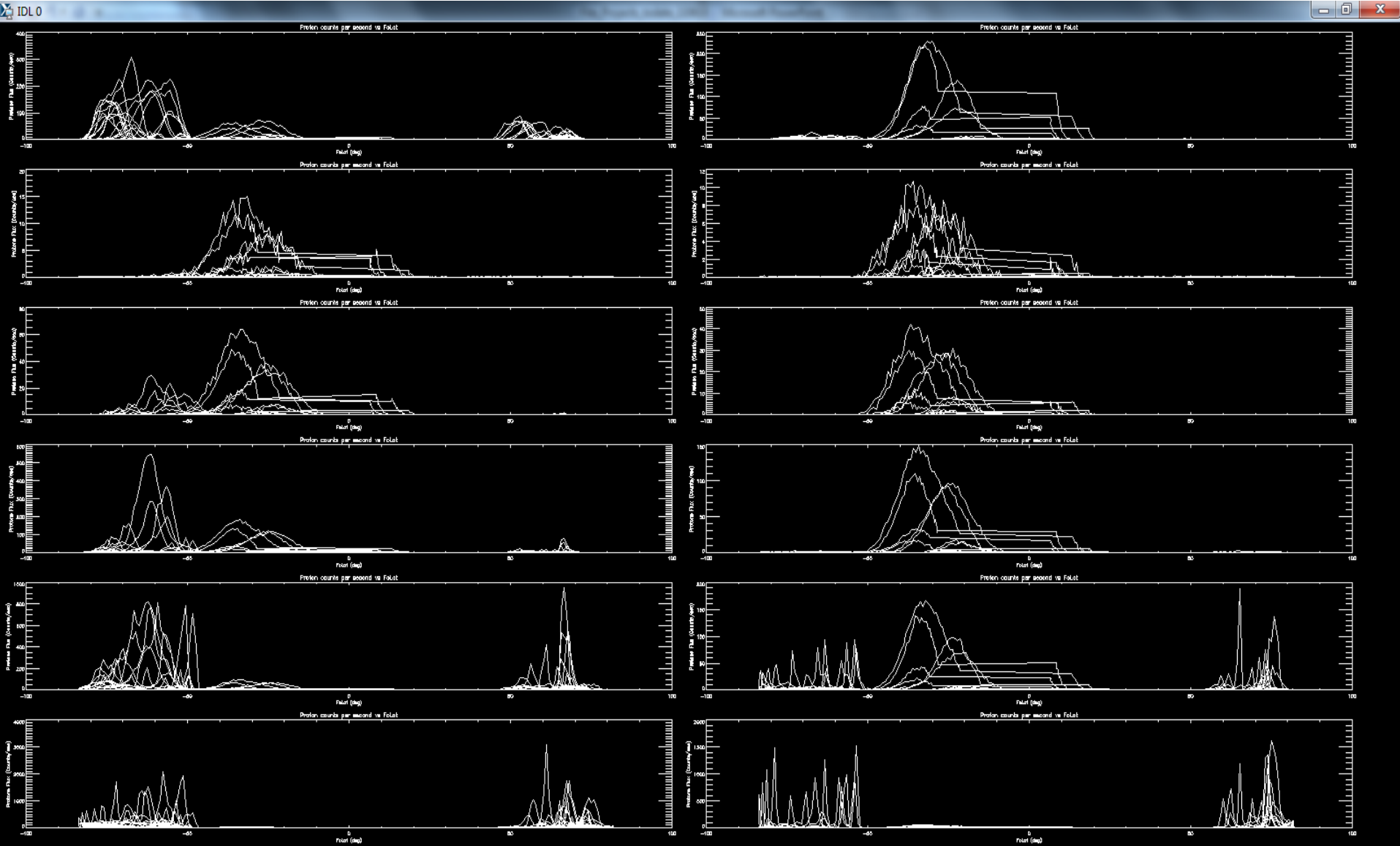

POES 17, cont'd

- Electron Telescopes
 - Telescope 1 Oriented Along Velocity Vector
 - Telescope 2 Oriented 90° from Velocity Vector
- 3 Linear, Silicon Chips per Telescope
- Electron Channels Info
 - Channel 1: $30\text{keV} < 100\text{keV}$
 - Channel 2: $100\text{keV} < 300\text{keV}$
 - Channel 3: $> 300\text{keV}$

Overview, Pt. 2

- Algorithm
- Data Results
 - 18 Bins
 - 180 Bins
 - 1800 Bins

Algorithm

- Read Array of (41, 5400) from text file
- Sort through desired data and form new arrays with desired data
- Reform the arrays
- Enter the resolution/number of bins to be used
- Series of Loops to process data

18 Bins

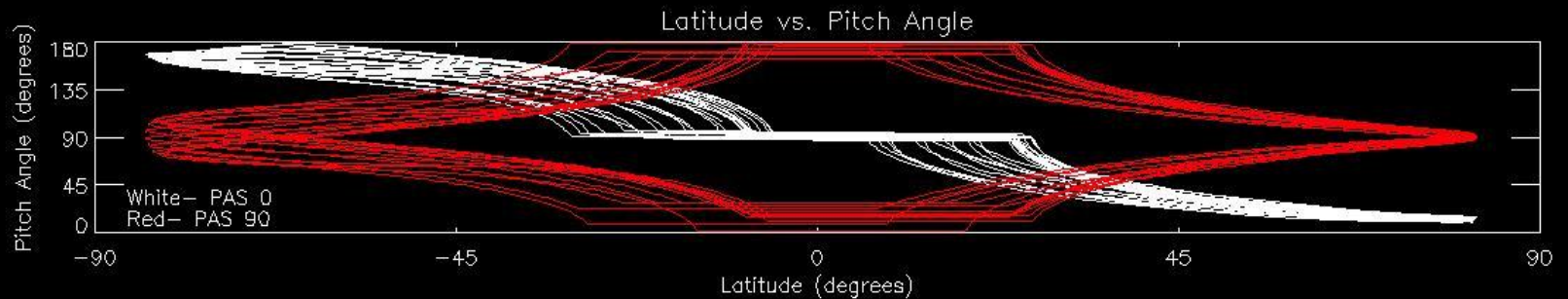
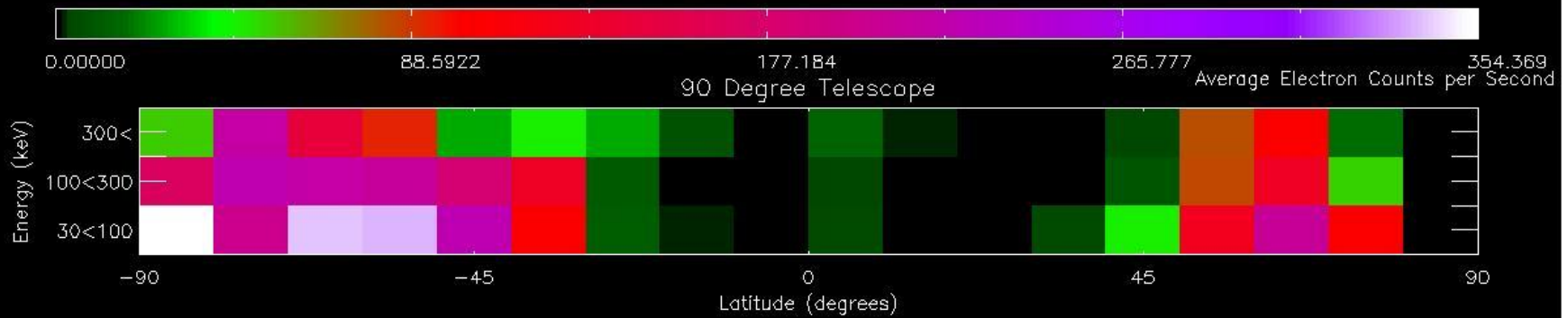
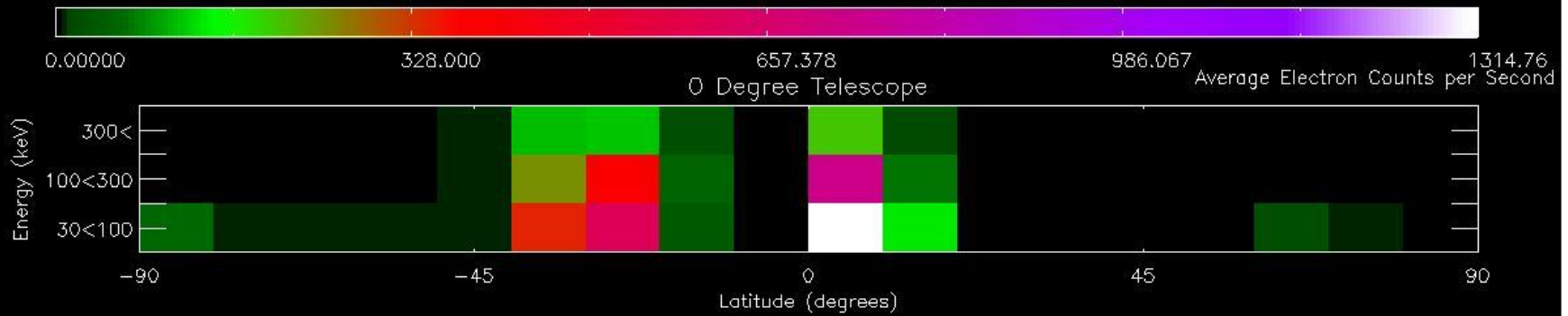

180 Bins

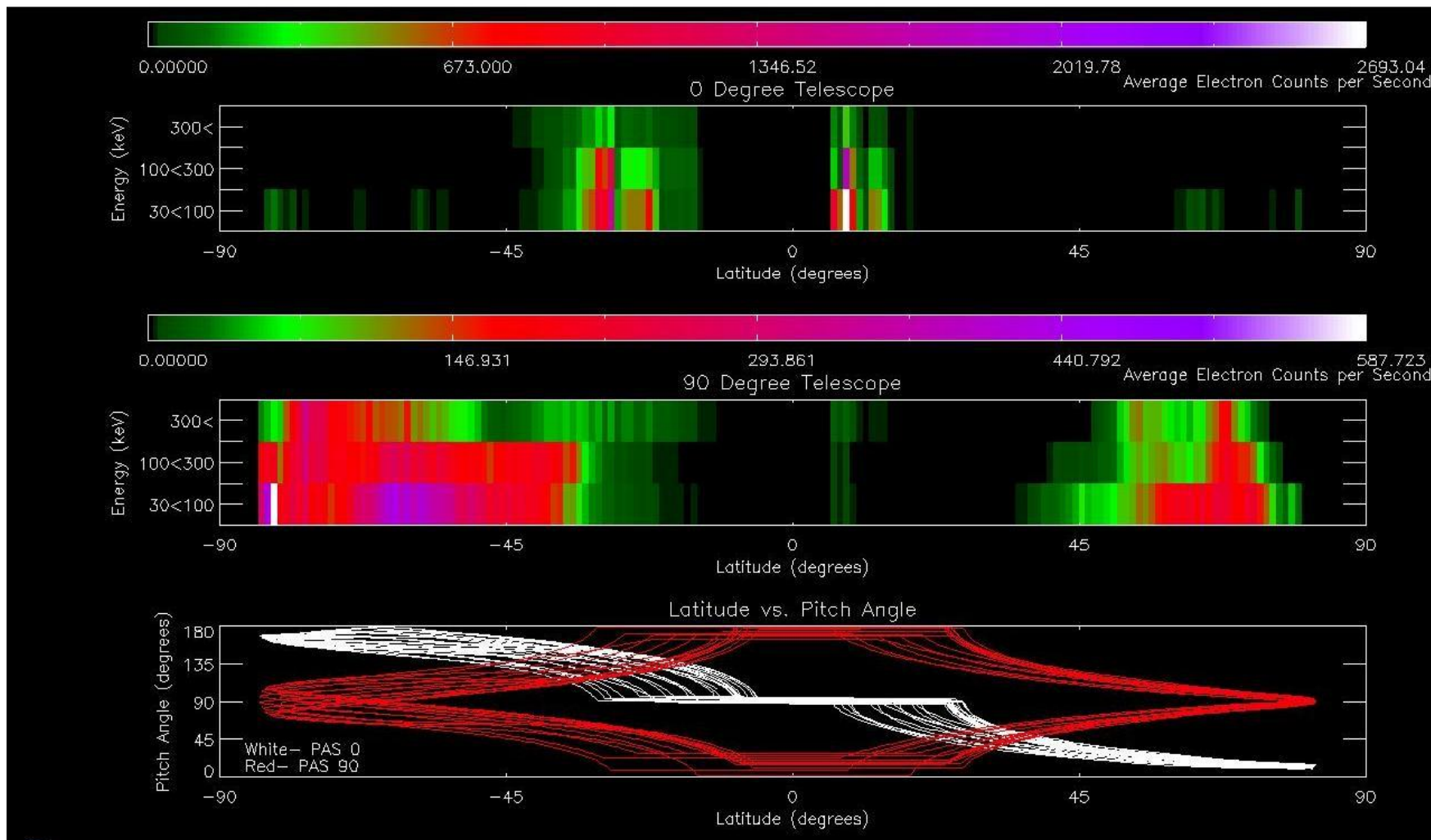

Terminal Synopsis of Data

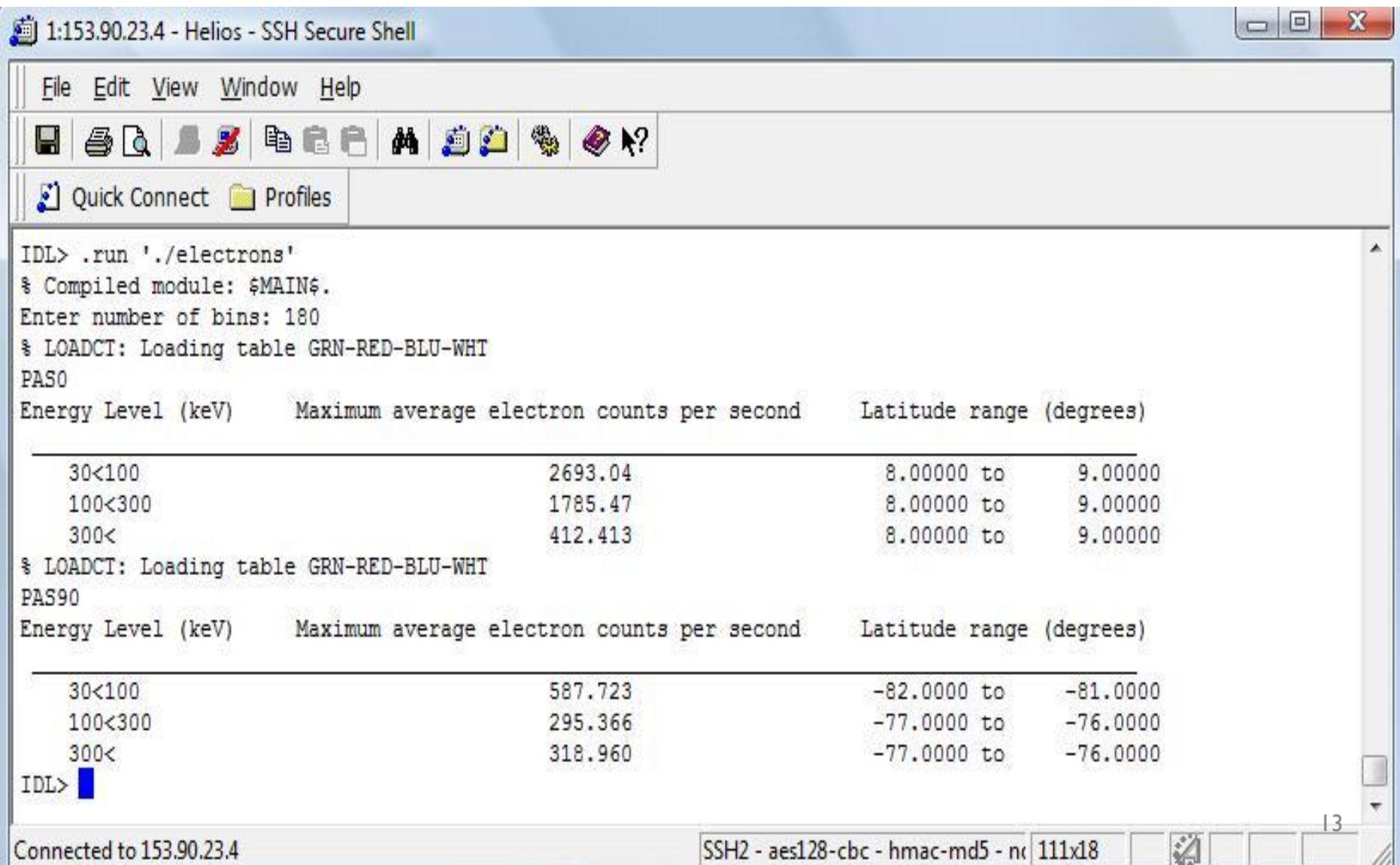

The screenshot shows a terminal window titled "1:153.90.23.4 - Helios - SSH Secure Shell". The terminal displays the execution of an IDL script named "electrons". The script processes two data tables: "GRN-RED-BLU-WHT" (PAS0) and "GRN-RED-BLU-WHT" (PAS90). For each table, it outputs a table with three columns: "Energy Level (keV)", "Maximum average electron counts per second", and "Latitude range (degrees)".

```
IDL> .run './electrons'
% Compiled module: $MAIN$.
Enter number of bins: 180
% LOADCT: Loading table GRN-RED-BLU-WHT
PAS0
Energy Level (keV)      Maximum average electron counts per second      Latitude range (degrees)
-----
 30<100                  2693.04                      8.00000 to 9.00000
100<300                  1785.47                      8.00000 to 9.00000
300<                     412.413                      8.00000 to 9.00000
% LOADCT: Loading table GRN-RED-BLU-WHT
PAS90
Energy Level (keV)      Maximum average electron counts per second      Latitude range (degrees)
-----
 30<100                  587.723                      -82.0000 to -81.0000
100<300                  295.366                      -77.0000 to -76.0000
300<                     318.960                      -77.0000 to -76.0000
IDL>
```

At the bottom of the terminal window, the status bar shows "Connected to 153.90.23.4" and "SSH2 - aes128-cbc - hmac-md5 - n 111x18".

1800 Bins

