

Twisting and Writhing with George Ellery Hale

Magnetic Helicity: from Turbulent
Convection to Space Weather

Richard C. Canfield
Department of Physics
Montana State University, Bozeman



Solar Activity Context

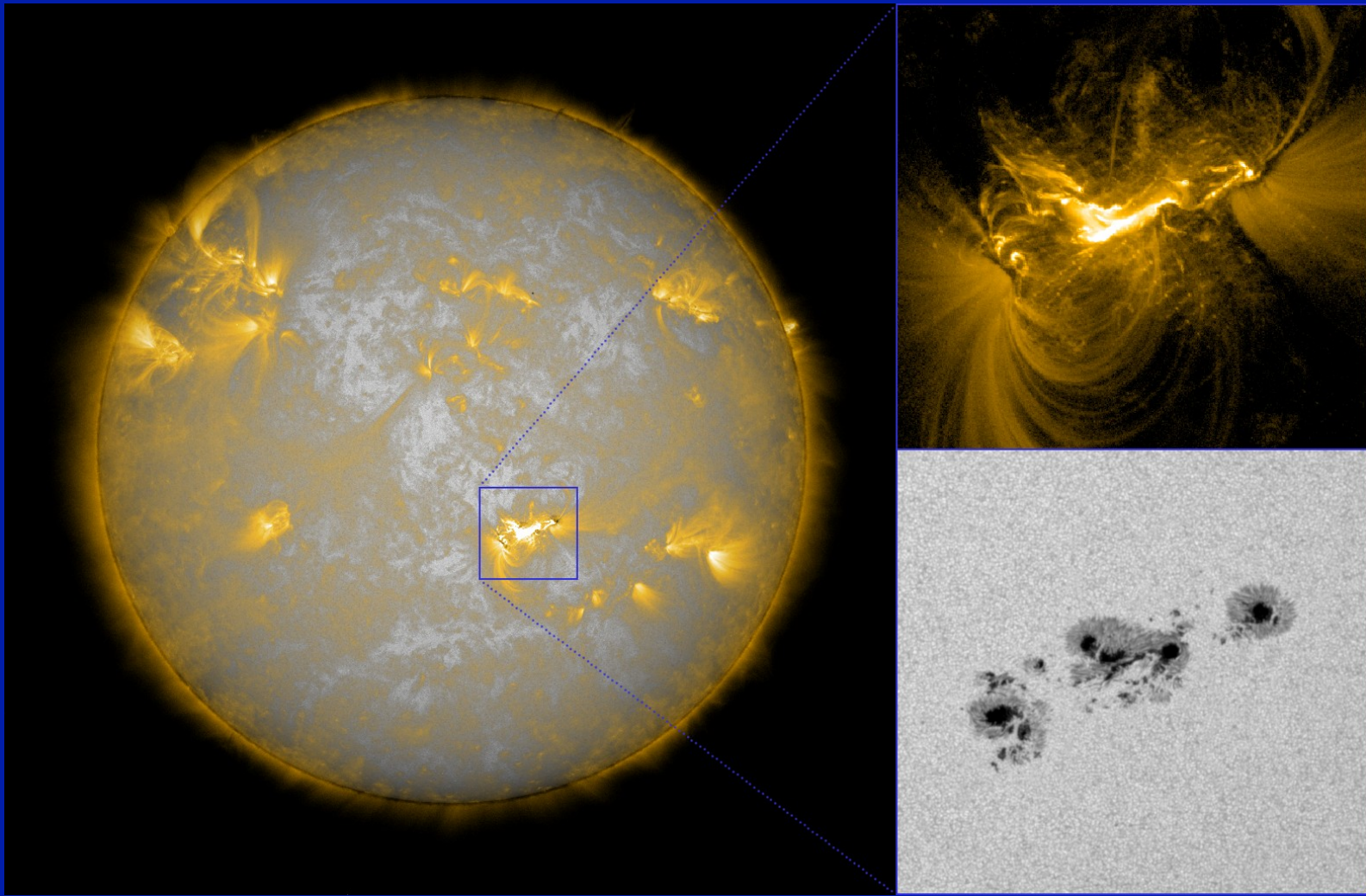

Data courtesy of SDO Atmospheric Imaging Assembly & Helioseismic & Magnetic Imager
NOAA AR 11158 video courtesy of Daniel Brown, University of Central Lancashire

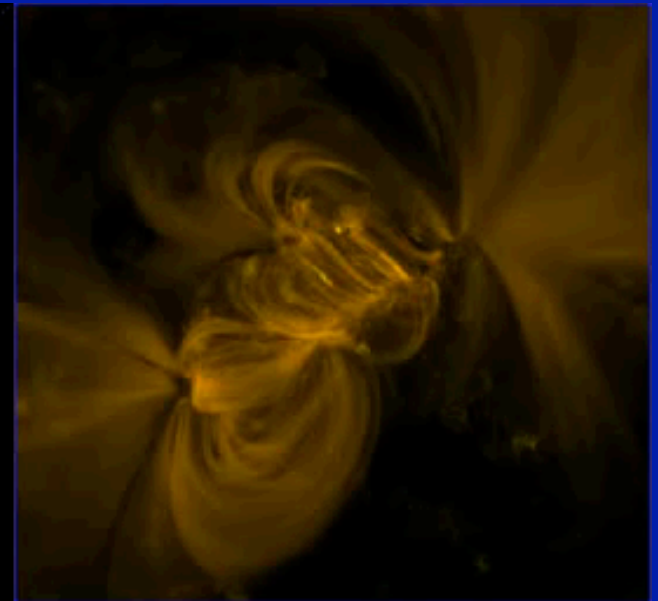
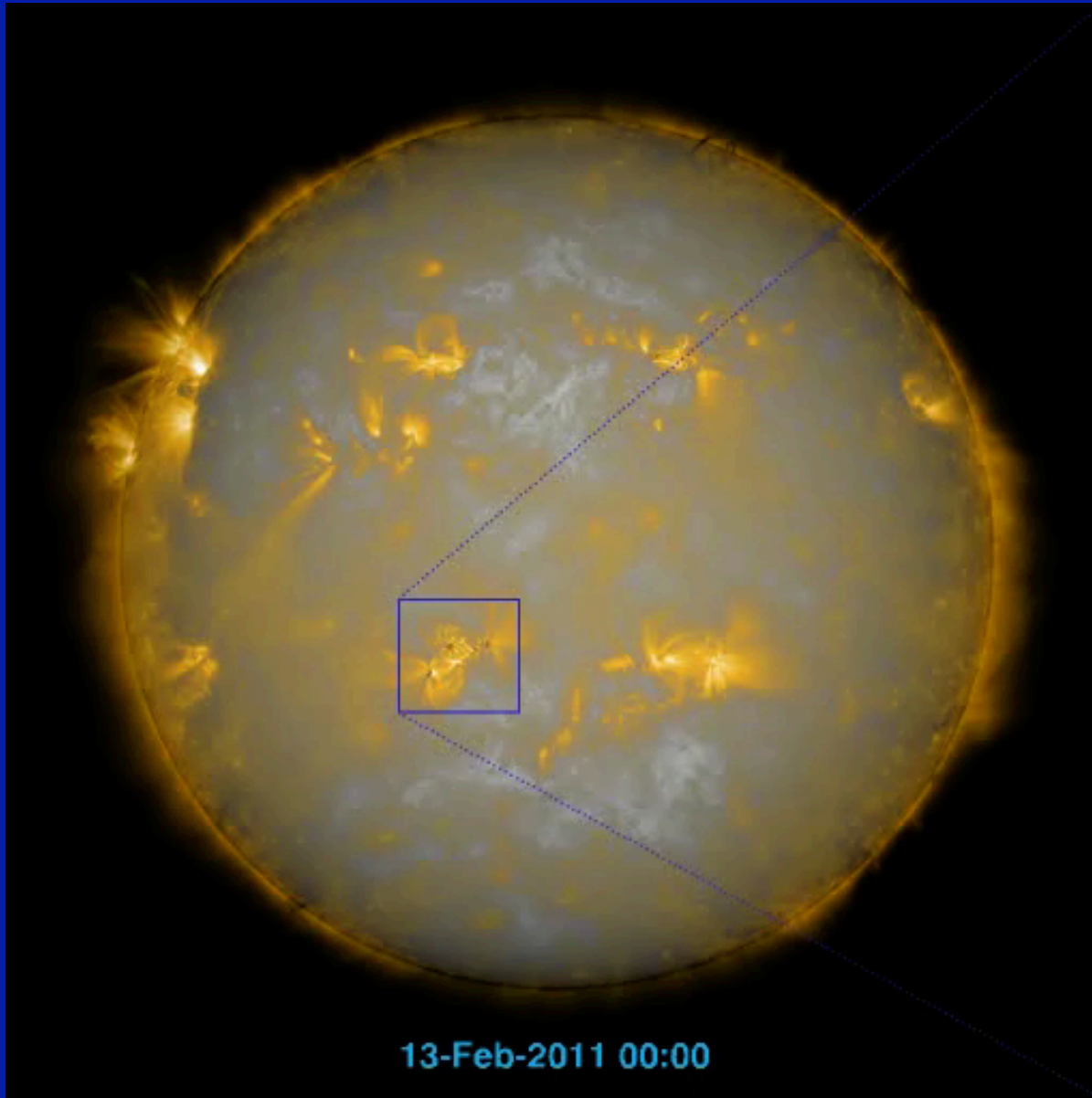

Data courtesy SDO Atmospheric Imaging Assembly & Helioseismic & Magnetic Imager
Video of AR 11158 and its context courtesy of Daniel Brown, University of Central Lancashire

Babcock's Dynamo Model

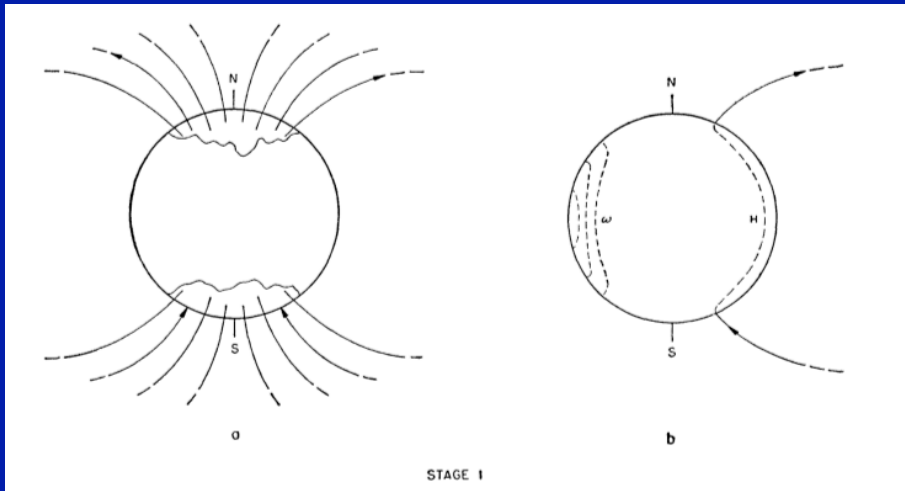

Key features:

- Primordial field
- Differential rotation in SCZ, not core
- Buoyancy \rightarrow Ω loops
- Ω loops \rightarrow sunspots, Active regions

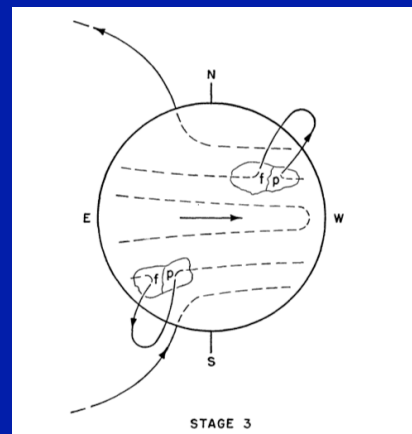
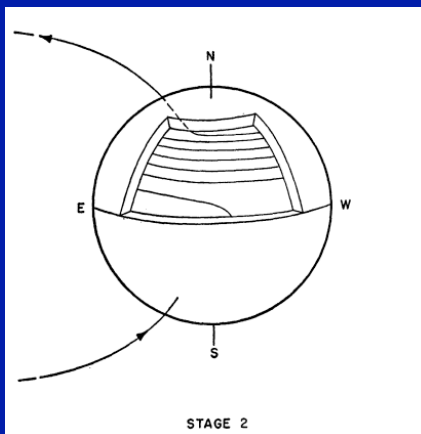

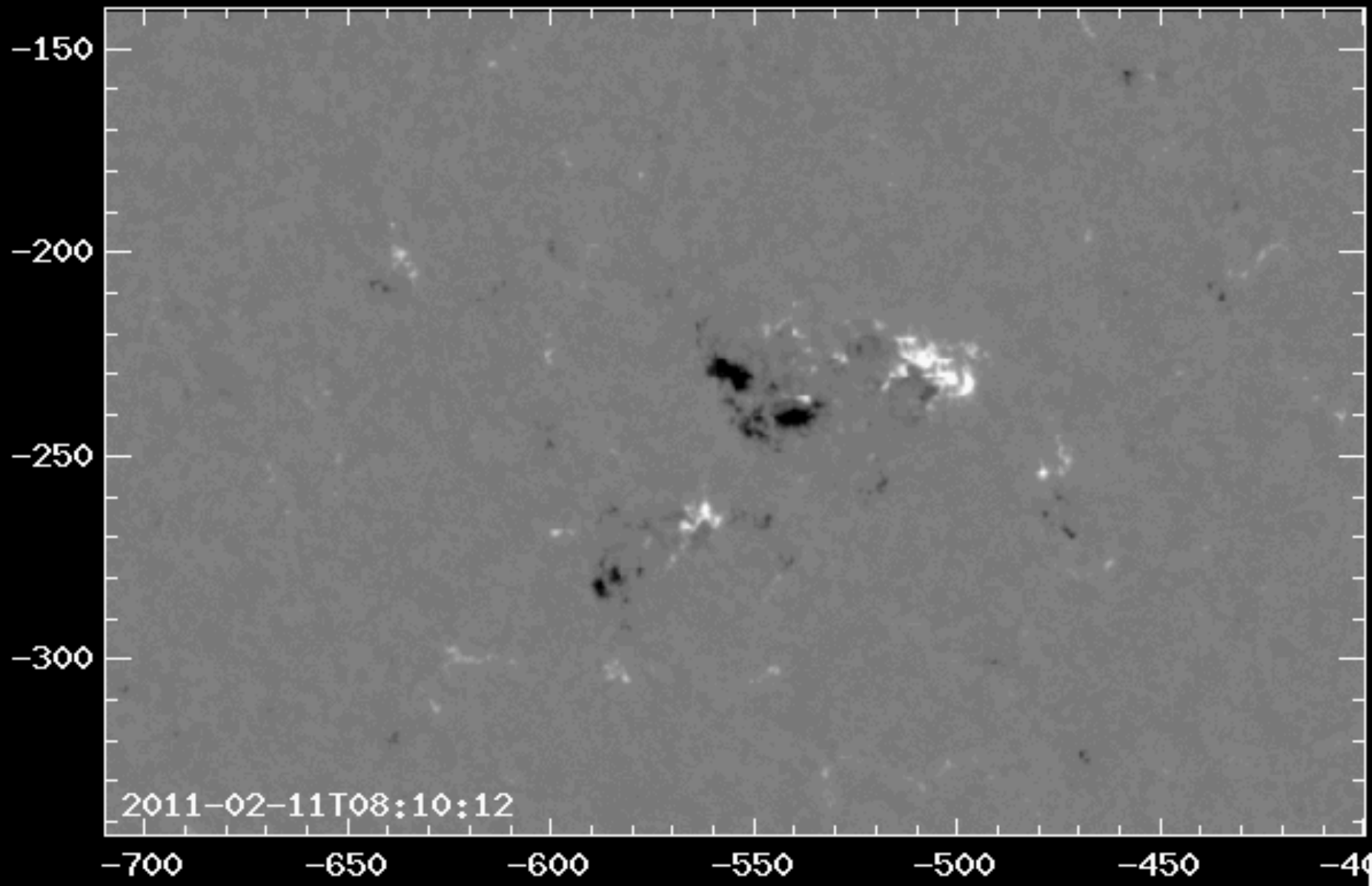

SDO Helioseismic & Magnetic Imager (HMI)
NOAA AR11158 video courtesy Lucas Tarr

Inferring Subsurface Structure

- Stack 800 HMI magnetograms
- 1 mtgm every 7.5 min for 100 hours)
- Red / blue: negative / positive polarity
- Assume structure is rigid, rises with constant velocity

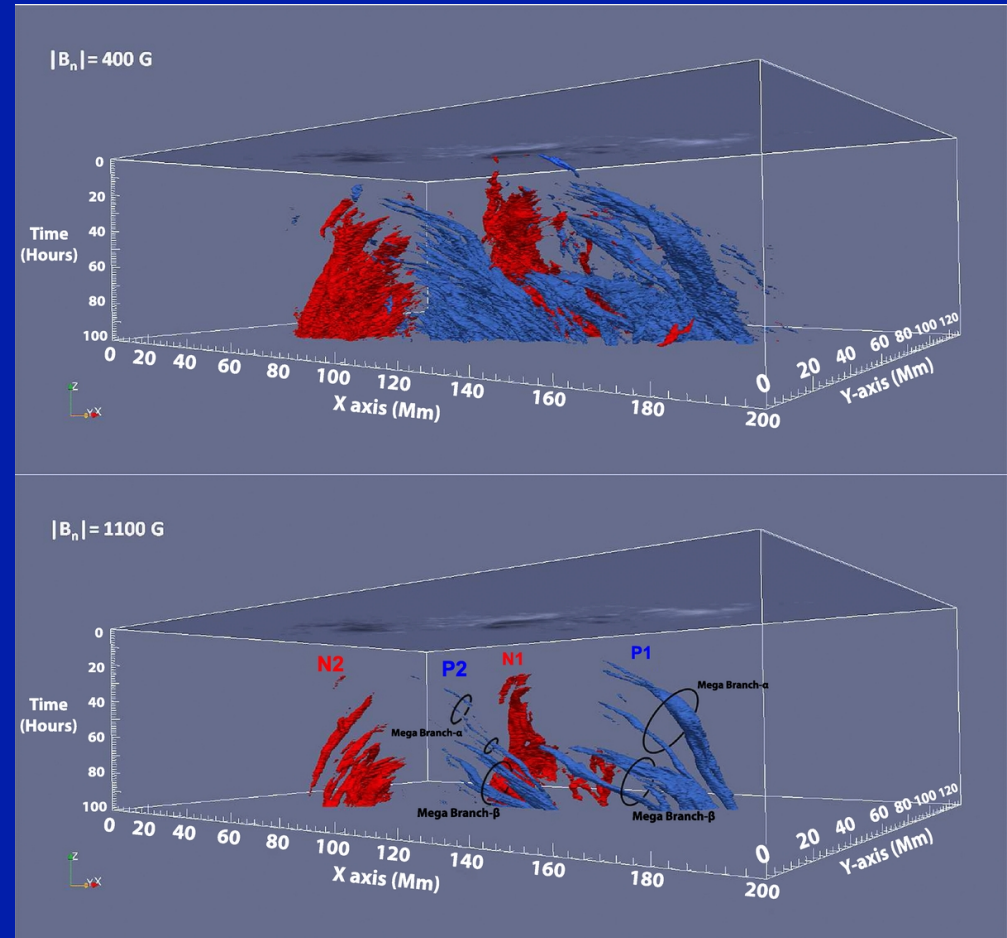



Hale's "Vortices (1908)"

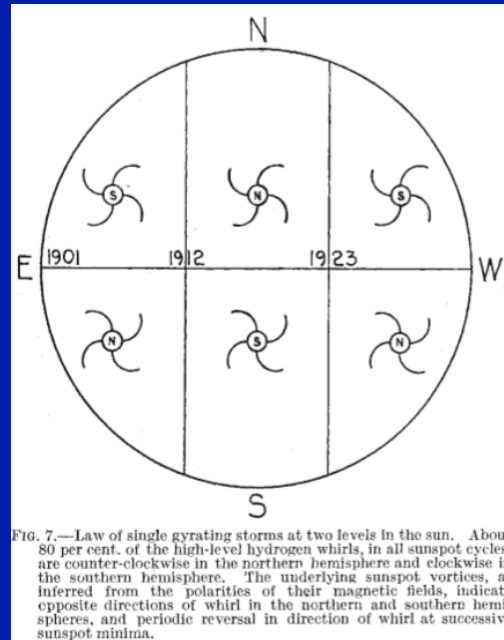

Hale, ApJ 1927

- Vortex direction depends on hemisphere, not cycle
- Observed in $H\alpha$, i.e. solar chromosphere, where $\beta = \rho_g/\rho_B < 1$, unbeknownst to Hale

Northern Hemisphere
(left handed upwelling)

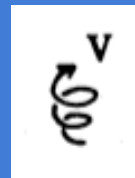

Southern Hemisphere
(right handed upwelling)

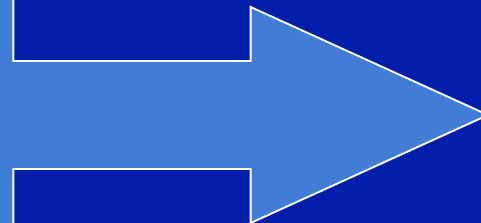
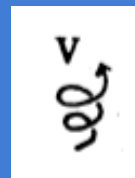

Magnetohydrodynamics: Fluid Dynamics + Electromagnetism

- Mass conservation
- Momentum conservation
- Internal energy conservation
- Faraday's equation
- Ampere's law
- Gauss's law
- Ohm's law
- Equation of state



$\mathbf{B}, \mathbf{v}, p, \rho$

Magnetohydrodynamics: Magnetic Helicity + Force-Free Fields

$$H \equiv \int A \cdot B \, d^3 x$$

“We then, by the way, find ... that $\mathbf{A} \cdot \mathbf{B}$ is a constant of the motion.”
Elsasser, Rev Mod Phys 1956

where $\mathbf{B} = \nabla \times \mathbf{A}$

Minimizing

$$E = \frac{1}{8\pi} \int B^2 \, d^3 x - \frac{\alpha}{8\pi} \int A \cdot B \, d^3 x$$

where α is a Lagrange multiplier, leads to the equation

$$\nabla \times \mathbf{B} = \alpha \mathbf{B}$$

for “force-free” ($\mathbf{j} \times \mathbf{B} = 0$) fields.
N.B.: α is a measure of twist
(constant when E is minimum).

Thin Flux Tubes: Twist, Writhe, & Helicity Conservation

Writhe
(W)

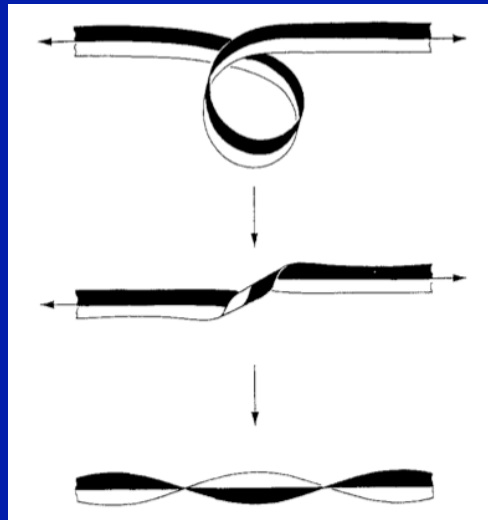

Twist
(T)

Moffatt & Ricca Proc. R.
Soc. Lond. A, 1992

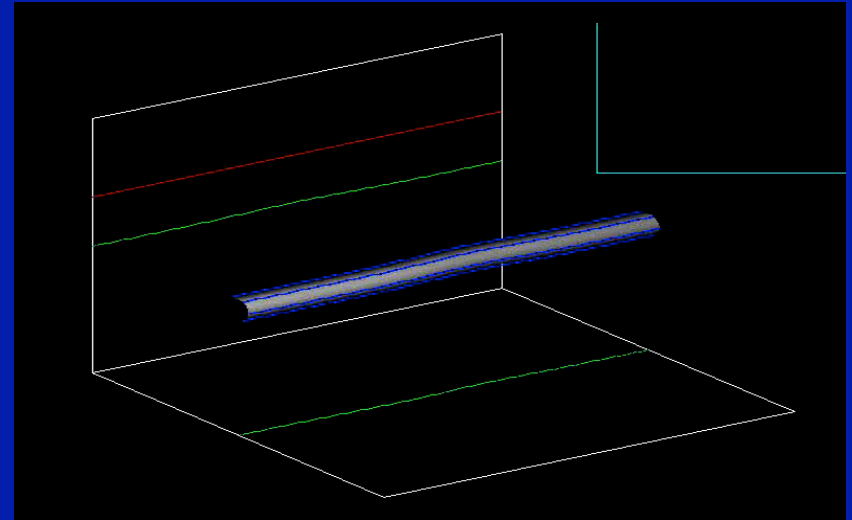

Video courtesy of Dana Longcope

Magnetic
Helicity
(H_m)

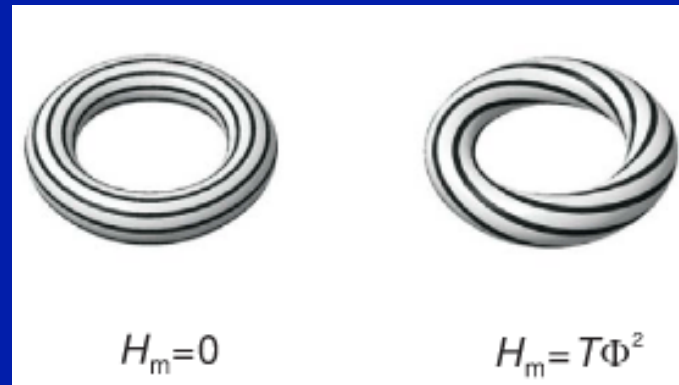

Wiegelmann & Sakurai LRSP

Hale's Vortices in Modern Data: SDO/HMI Vector Magnetogram

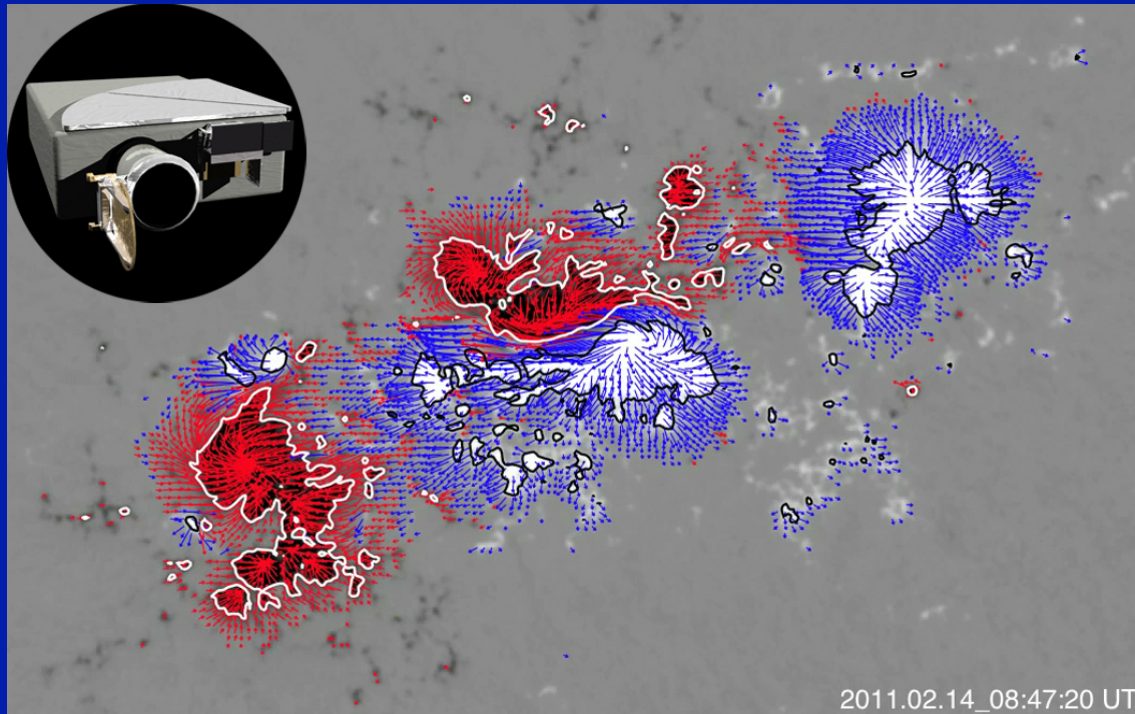

SDO Helioseismic & Magnetic Imager

$$\nabla \times B = \alpha B$$

Hale's Vortices Revisited: The Hemispheric Helicity Rule

Solar Cycle 22
203 Active
Regions

Solar Cycle 23
263 Active
Regions

$$\nabla \times \mathbf{B} = \alpha \mathbf{B}$$

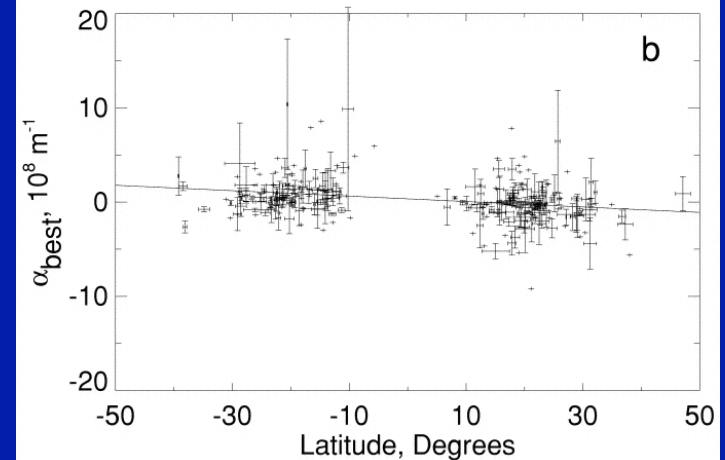
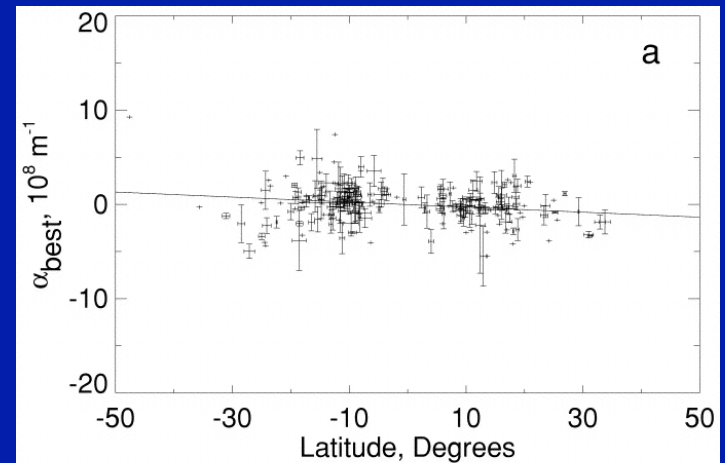

Flux-Tube Twist from Helical Convective Turbulence



National Geographic / Universe Today

Σ Effect Model:

- Horizontal thin flux tube
- Helical convective turbulence
- Mixing length theory, velocity
- Monte Carlo approach
- Conservation of helicity

Northern hemisphere

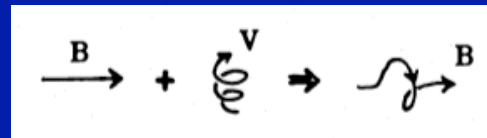

Southern hemisphere

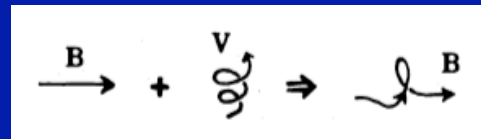

Glatzmaier ApJ 1985

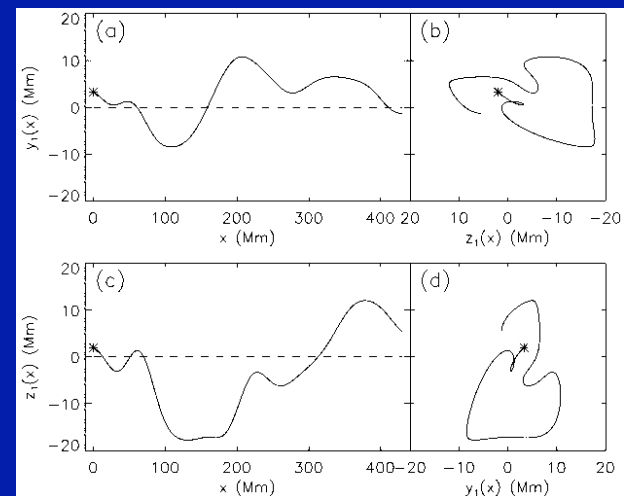

Longcope, Fisher, Pevtsov ApJ 1998

Flux-Tube Twist Resulting from Convective Turbulence

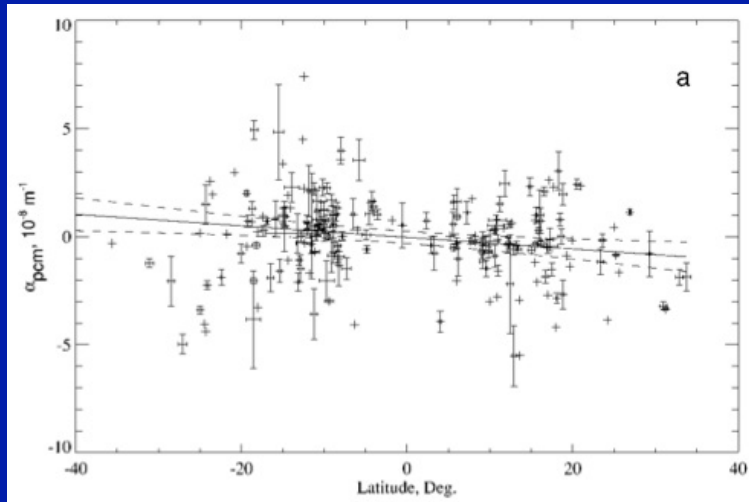

Pevtsov Canfield Metcalf 1996 ApJ

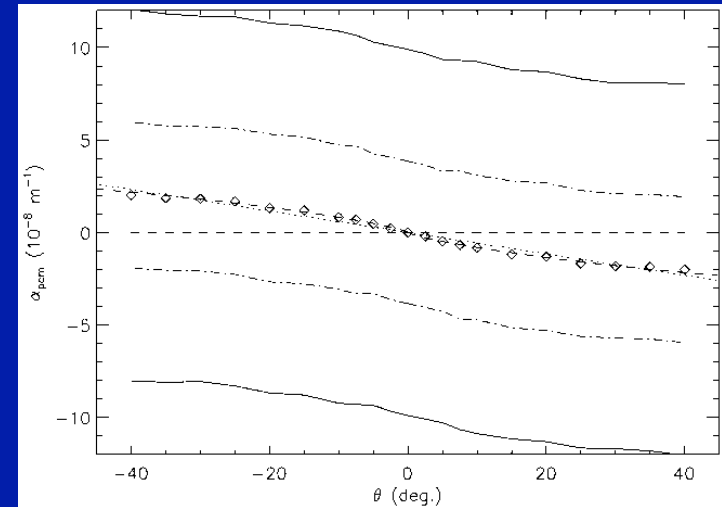

Longcope Fisher Pevtsov 1998 ApJ

- Success! Coriolis force + convective turbulence + helicity conservation \rightarrow North/South -/+ twist, no solar cycle dependence, intrinsic scatter.

“THE SOLUTIONS ALL ARE SIMPLE ...
AFTER YOU’VE ALREADY ARRIVED AT THEM.
BUT THEY’RE SIMPLE ONLY WHEN
YOU ALREADY KNOW
WHAT THEY
ARE”

Robert M. Pirsig
Zen and the Art of Motorcycle Maintenance

Thin Flux Tubes: Self & Mutual Helicity

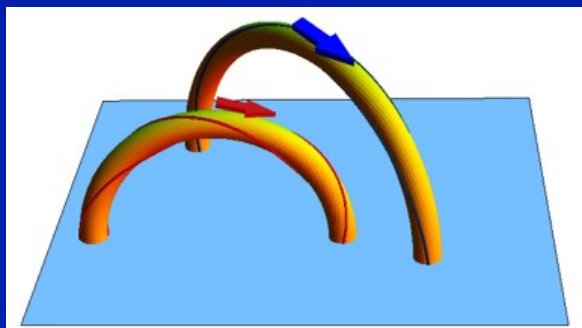
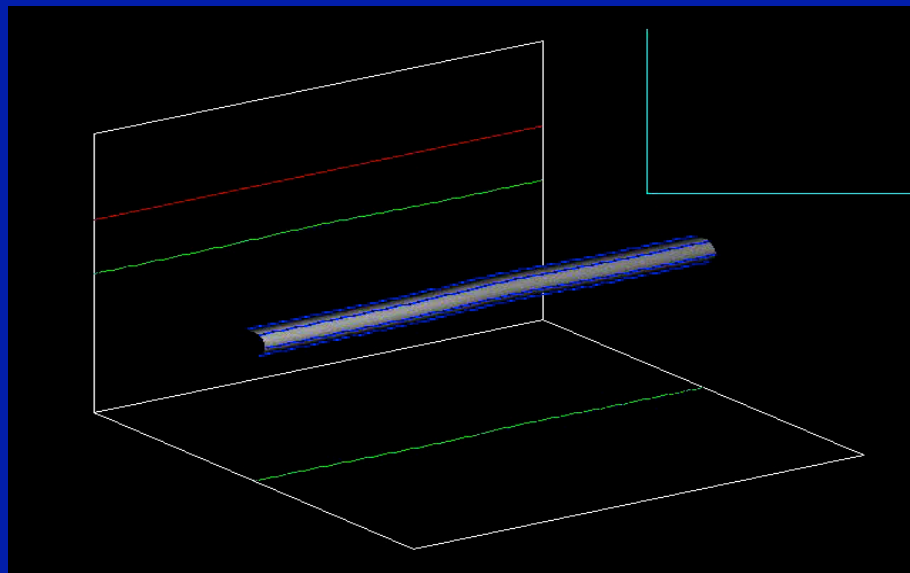
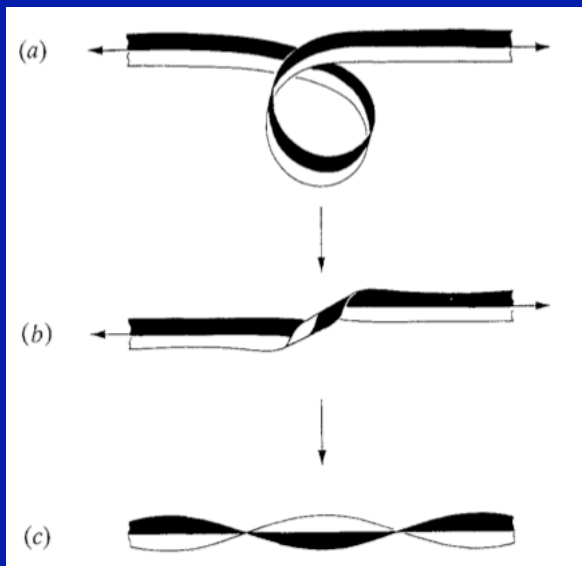

$$\begin{aligned}
 H_1 &= 1.5 \Phi_1^2 \\
 H_2 &= -1.2 \Phi_2^2 \\
 H_{12} &= 0.22 \Phi_1 \Phi_2 \\
 H &= H_1 + H_2 + H_{12}
 \end{aligned}$$

Self Helicity: H_1, H_2
 Mutual: H_{12}
 $H_{\text{self}} = \text{Twist} + \text{Writhe}$
 $H = H_{\text{self}} + H_{\text{mutual}}$

Courtesy of Mitch Berger

Flux Rope Formation: Photospheric motions & Magnetic Reconnection

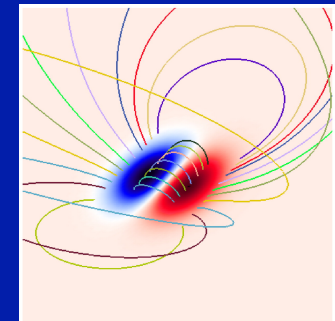
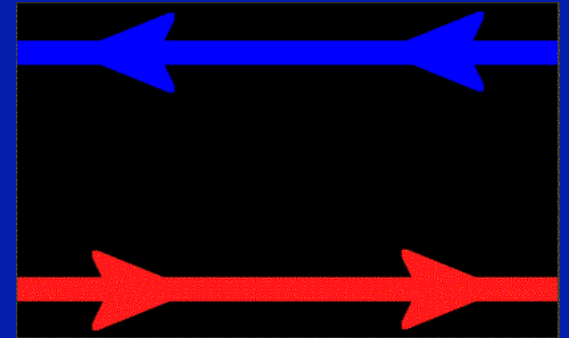
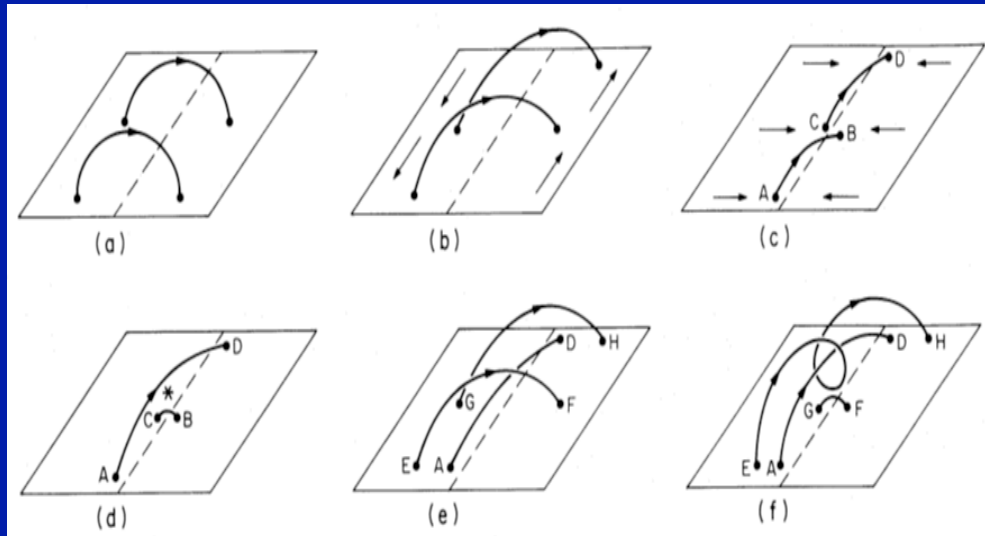

van Ballejoijen & Martens ApJ 1989

Reconnection + Helicity Conservation
Mutual Helicity \rightarrow Self Helicity

MHD Numerical Simulation

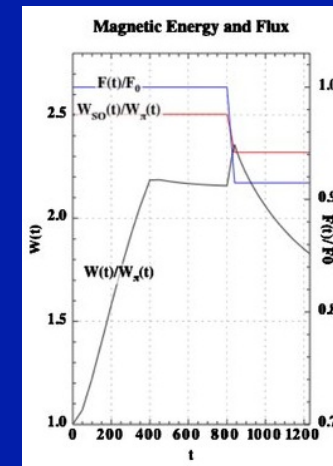
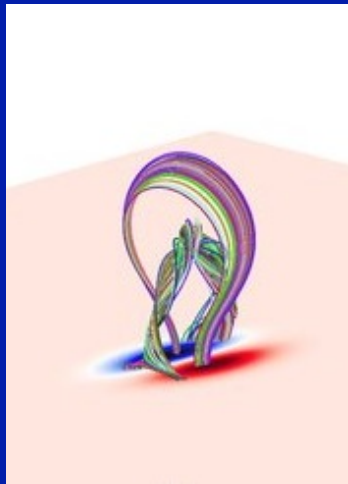
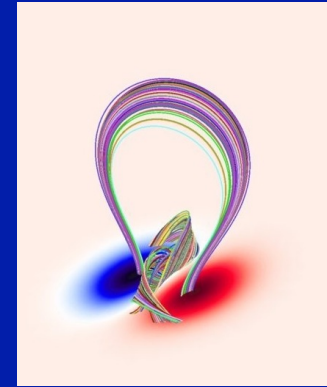
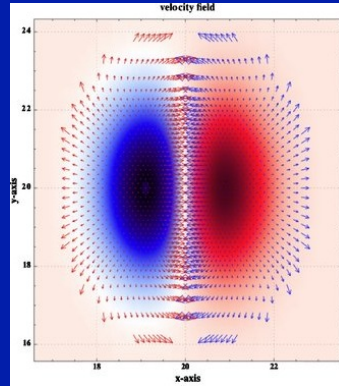
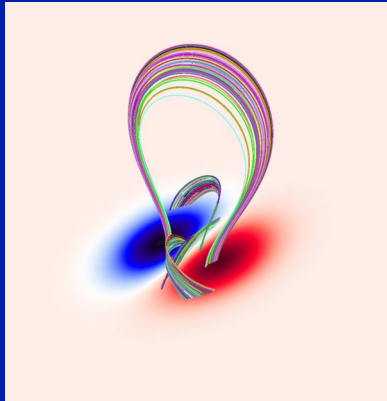

Coronal Mass Ejections (CMEs) Are Flux Ropes

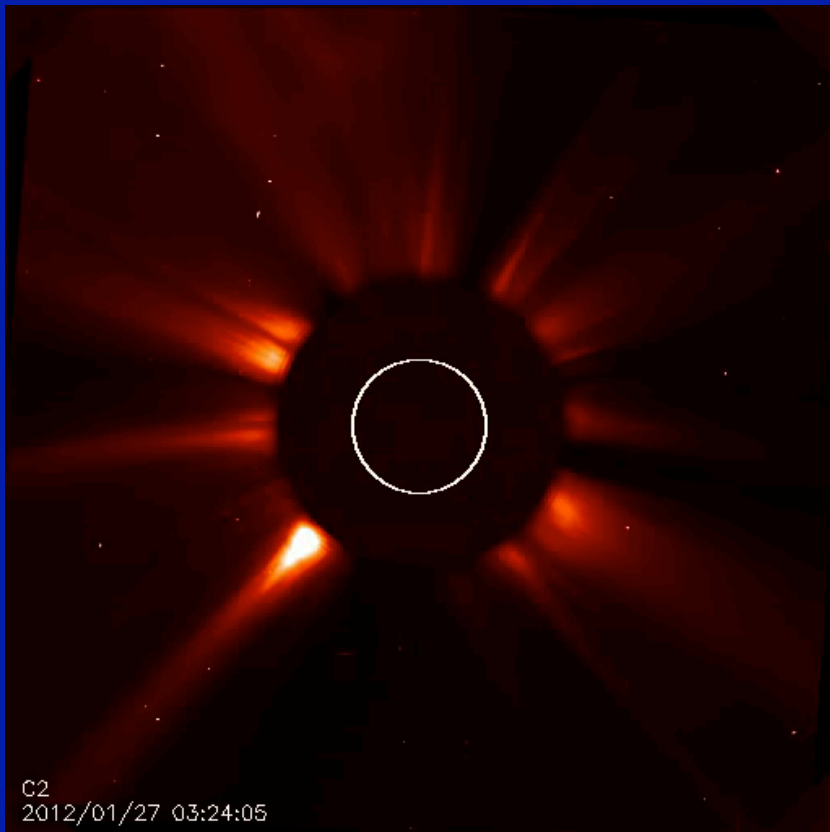

Vourlidas et al ApJ 2012

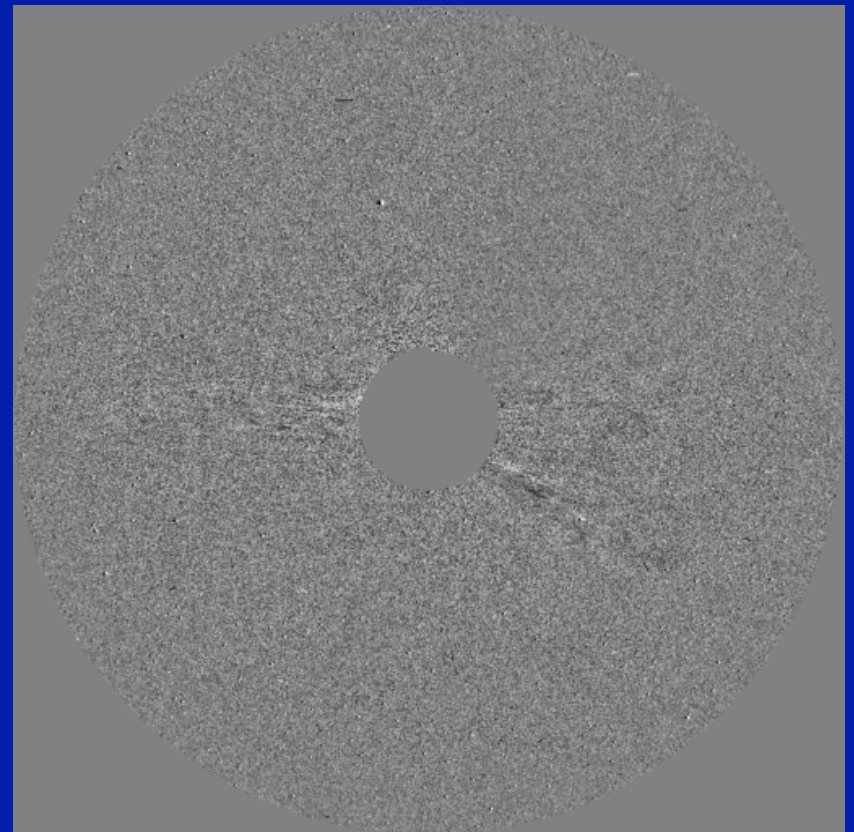

Courtesy of Ben Lynch

Flux Ropes in the Interplanetary Medium

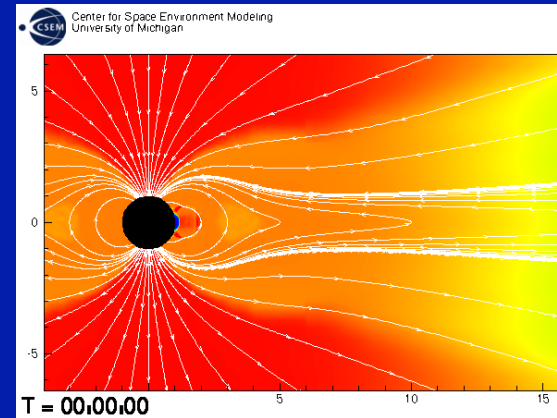
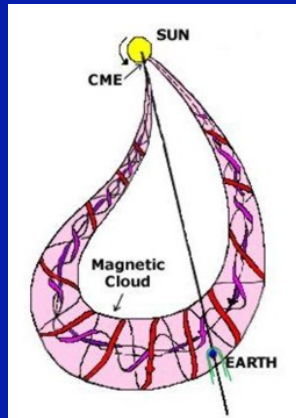

Space Weather challenge:
predict velocity, density, and
magnetic field orientation when
solar eruptions arrive at Earth

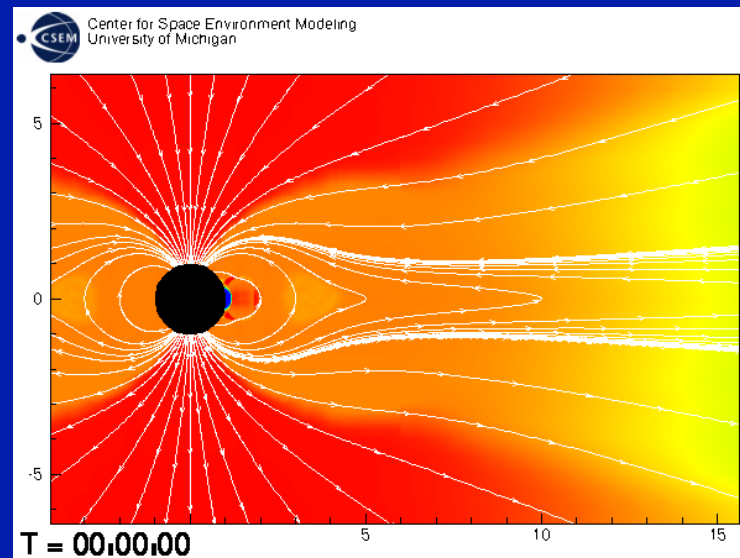

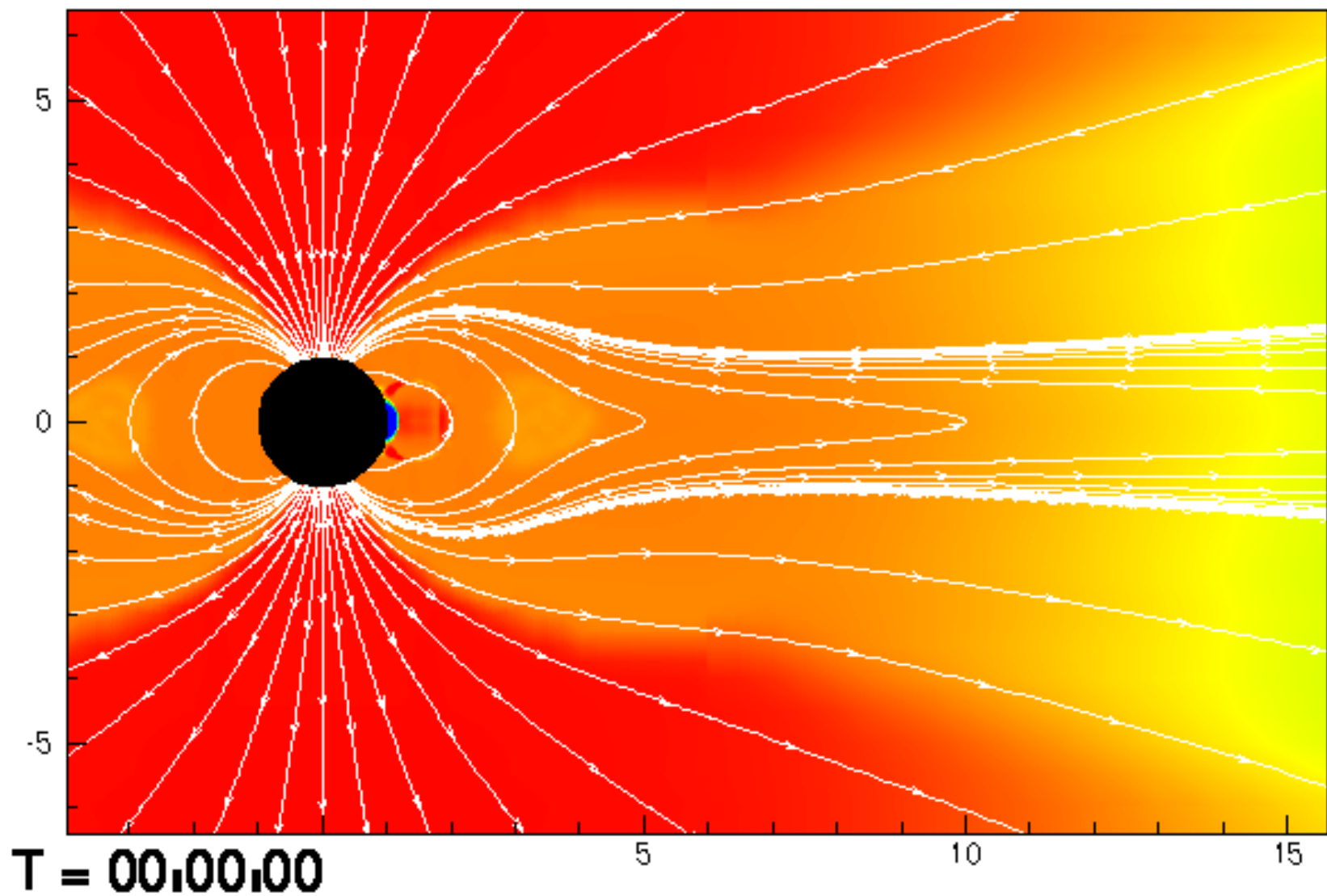

Energy and Helicity Flux from Magnetogram Sequences

$$\frac{dE}{dt} = \frac{1}{\mu_0} \int_{S_p} [B_t^2 v_n - (\mathbf{B}_t \cdot \mathbf{v}_t) B_n] ds$$

$$\frac{dH}{dt} = 2 \int_{S_p} [(A_P \cdot B_t) v_n - (A_P \cdot v_t) B_n] ds$$

Berger & Field (JFM 1984)
 Finn & Antonsen (CPPCF 1985)
 November & Simon (ApJ 1988)
 Chae et al (ApJL 2001)
 Kusano et al (ApJ 2002)
 Demoulin & Berger (SP 2003)

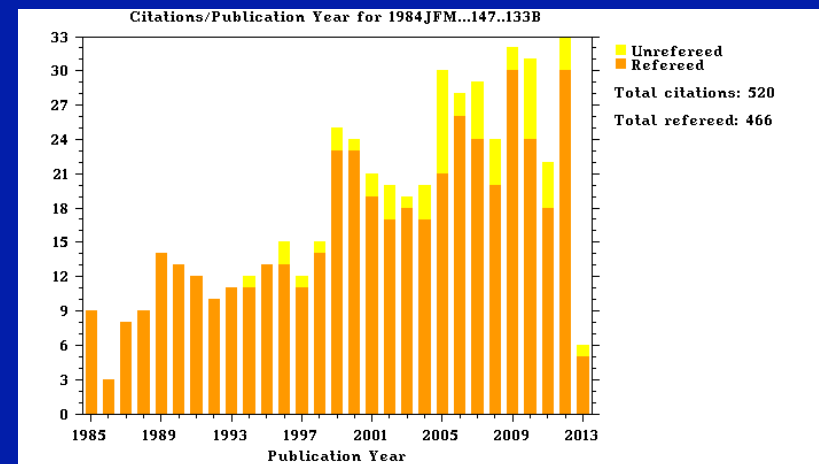

Energy and Helicity Storage in Active Region Coronae

MINIMUM CURRENT CORONA (MCC)

1. Separators are “fault lines” in the topology of the corona, where magnetic reconnection can take place.
2. Topology changes only when flare reconnection occurs and/or when flux emerges or submerges.
3. Currents build along separators σ in the corona, with no dissipation, until flare reconnection occurs.
4. When flare reconnection occurs, full dissipation of those separator currents accounts for flare Energy and Helicity
5. Physics: Faraday’s Law, Ohm’s Law, separator current self-inductance.
6. The MCC predicts E and H stored on all separators; use observations to identify which of them flare and the value of the reconnection flux.

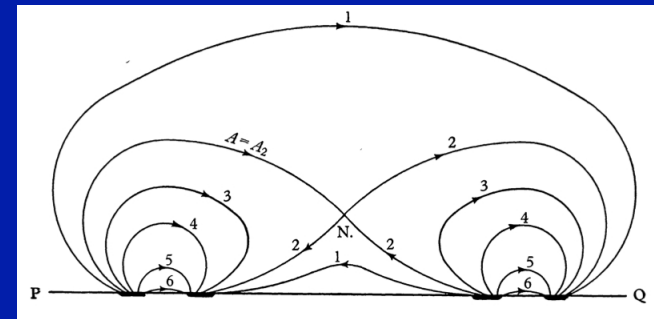

Sweet IAU Symposium 6, 1958

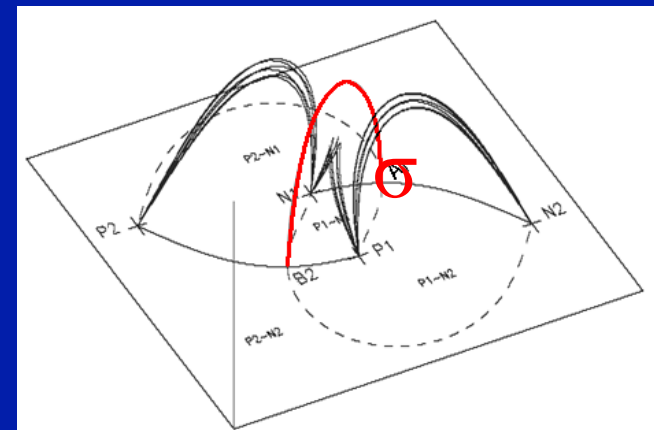

Courtesy of Dana Longcope

Estimating magnetic helicity of CMEs in interplanetary space

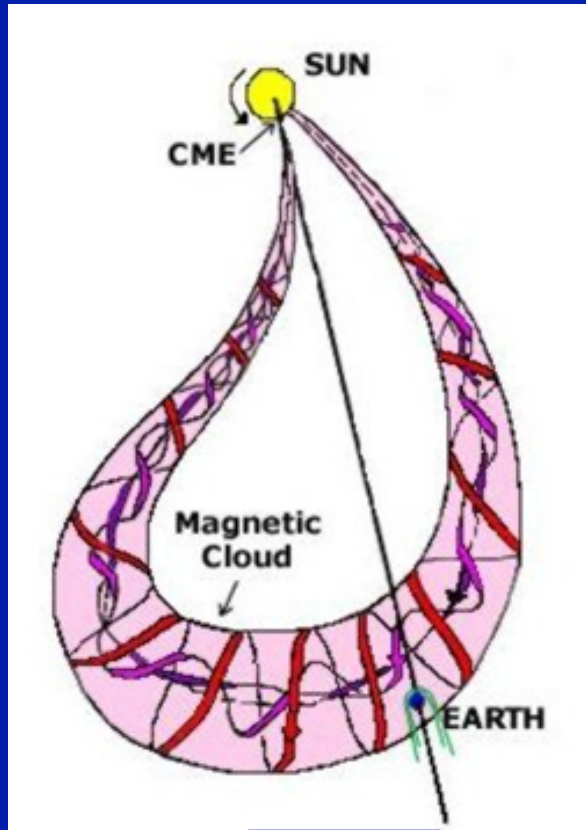

Grad-Shafranov fit (Hu & Sonnerup 2001)
to interplanetary data

Uncertainty: Twist distribution: $l = [0.5, 2.5]$ AU

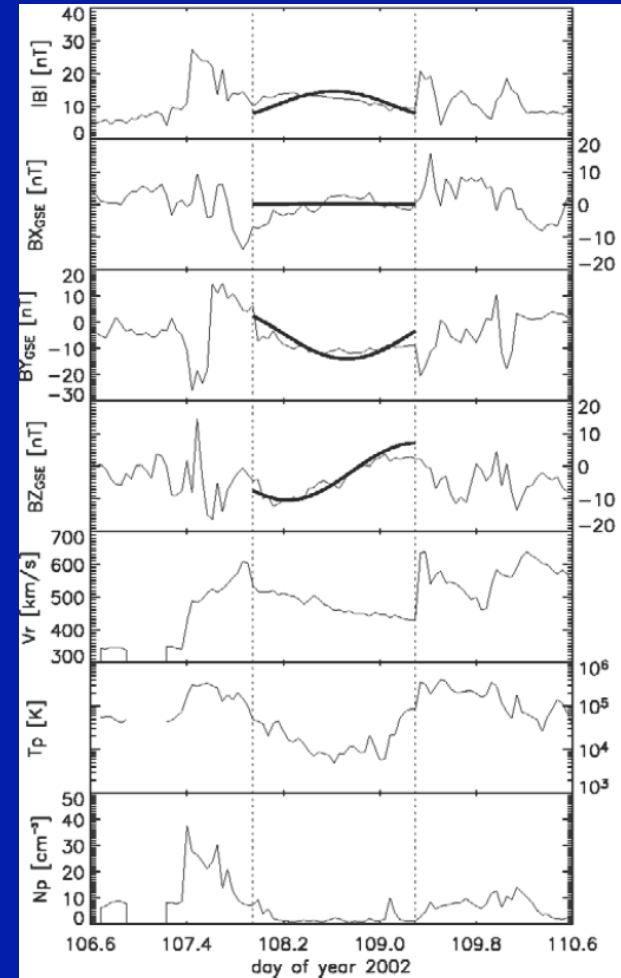

Predicted and observed Energy and Helicity values in four eruptive events

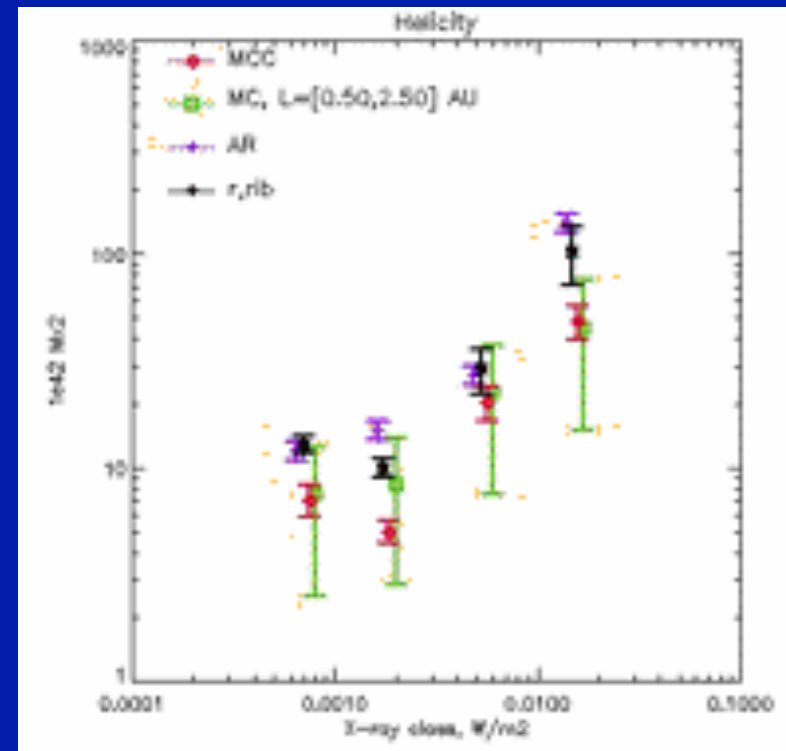
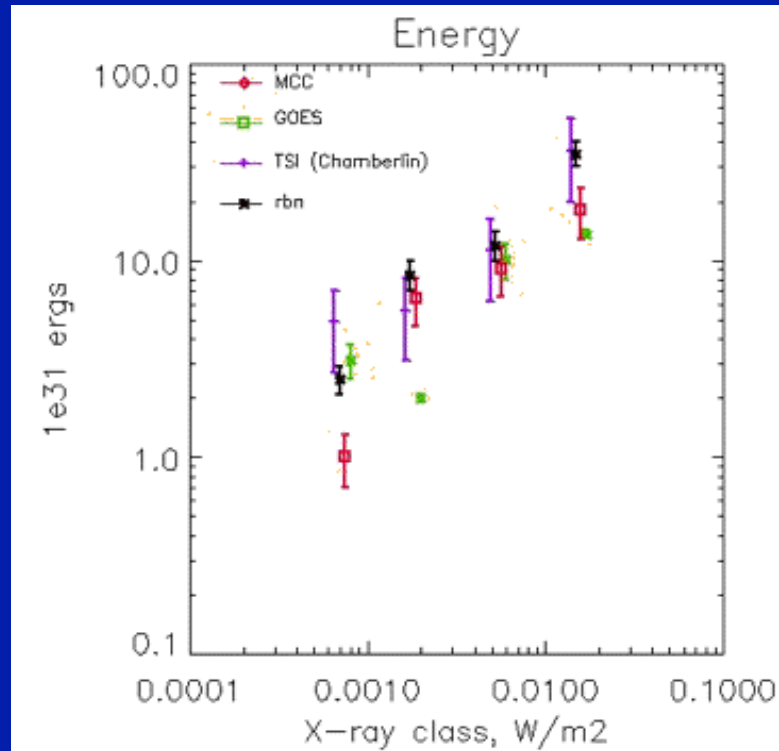

Kazachenko et al. 2010

Summary

The conservation properties of magnetic helicity:

- Link turbulent motions in the solar convection zone to the energetics and topology of solar eruptive events
- Make a crucial contribution to data-driven understanding of the solar genesis of Space Weather

Thanks

- Thanks to the Solar Physics Division for this honor
- Thanks to the following bright PhD students, postdocs, and REU students, for their invaluable contributions to my research and my life
- I am pleased to dedicate this talk to the memory of Thomas R. Metcalf

PhD Students

- Richard C. Puetter, Ph.D. (Physics), University of California, San Diego, 1980
- Paul J. Ricchiazzi, Ph.D. (Physics), University of California, San Diego, 1982
- Todd A. Gunkler, Ph.D. (Physics), University of California, San Diego, 1984
- George H. Fisher, Ph.D. (Physics), University of California, San Diego, 1984
- David H. Tamres, Ph.D. (Physics), University of California, San Diego, 1989
- Kenneth G. Gayley, Ph.D. (Physics), University of California, San Diego, 1990
- Thomas R. Metcalf, Ph.D. (Physics), University of California, San Diego, 1990
- Kimberly D. Leka Ph.D. (Astronomy), University of Hawaii, Honolulu, 1995
- Angela C. Des Jardins, Ph.D. (Physics), Montana State University, Bozeman, 2007
- Maria D. Kazachenko, Ph.D. (Physics), Montana State University, Bozeman, 2010

Postdoctoral Fellows

- Chang-Hyuk An, Ph.D. (Physics), University of Tennessee, 1979
- Stanley Owocki, Ph.D. (Physics), University of Colorado, 1981
- Jean-Pierre Wuelser, Ph.D. (Physics), University of Bern, 1988
- Thomas R. Metcalf, Ph.D. (Physics), UCSD, 1990
- Jean-Francoise de La Beaujardiere, Ph.D. (Astrophysical, Planetary, and Atmospheric Sciences), University of Colorado, 1990
- Edward Lu, Ph.D. (Physics), Stanford University, 1990
- Gianna Cauzzi, Ph.D. (Astronomy), University of Florence, 1992
- Alexei Pevtsov, Ph.D. (Solar and Planetary Physics), Institute of Solar-Terrestrial Physics, Irkutsk, 1992
- Tetsuya Magara, Ph.D. (Solar Physics), University of Kyoto, Japan 1998
- Robert Leamon, Ph.D. (Physics), University of Delaware, Newark, 1999
- Stephane Regnier, Ph.D. (Physics), Institute d'Astrophysique Spatiale, Orsay, 2001
- Dibyendu Nandi, Ph.D. (Physics), Indian Institute of Science, Bangalore, 2003

Research Experience for Undergraduate Students

- Robert Stencel, University of Michigan
- Marc Allen, University of Michigan
- James Rhoads, Harvard University
- Keith Lambkin, University College Dublin
- Tanya Freeman, Union College
- Ji Son, University of California, Los Angeles
- Crystal Fordyce, Clemson University
- Emily McLinden, University of Chicago
- Scott Waitukaitis, University of Chicago
- Michael Hahn, Cornell University
- Stacy Gaard, University of Indiana
- Alexander Russell, University of St Andrews
- Thomas Schad, University of Notre Dame
- Christopher Lowder, Georgia Institute of Technology
- Meghan Cassidy, University of Maryland
- William Simpson, University of St. Andrews

Finis

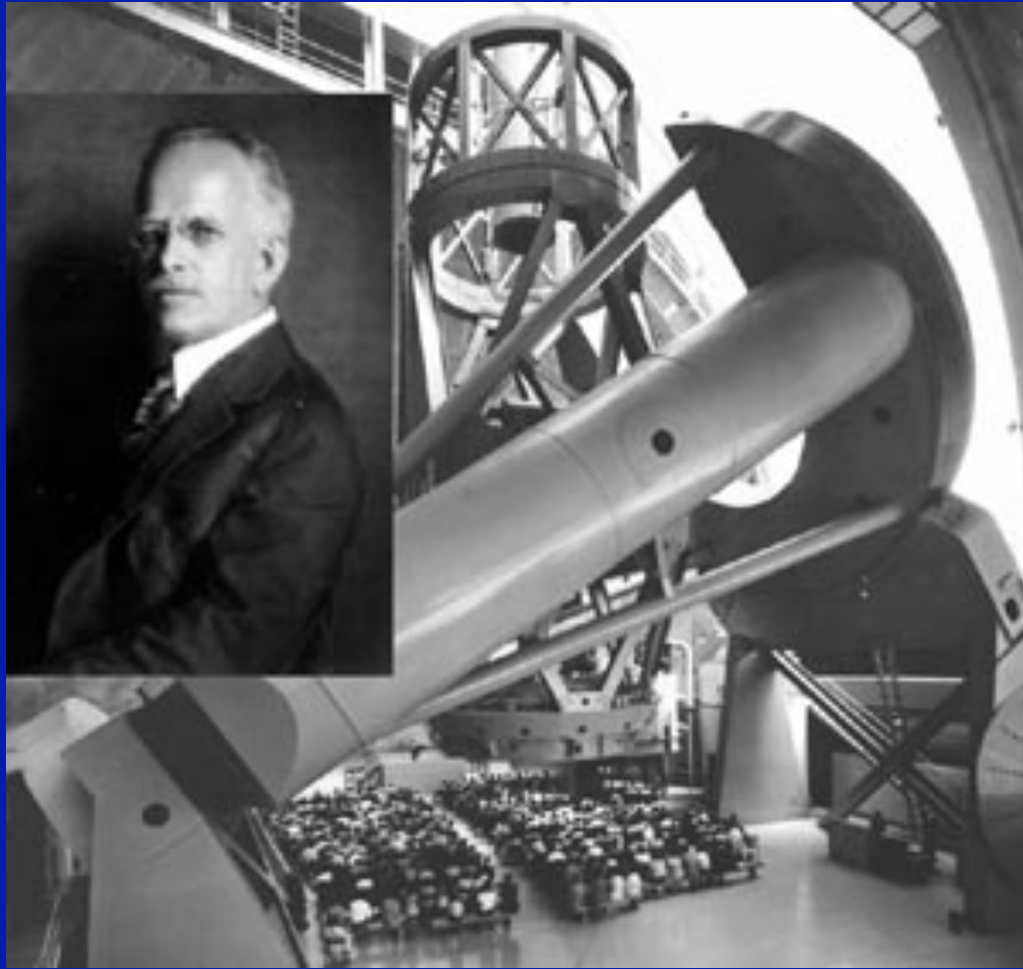

Journey to Palomar, Todd & Robin Mason