

Nearly everything I need to know about

Observing the Sun

I learned from Halliday & Resnick

Charles Kankelborg

2010 Solar Physics REU Program



MONTANA
STATE UNIVERSITY

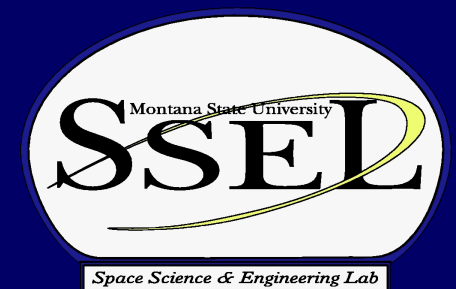

David Halliday

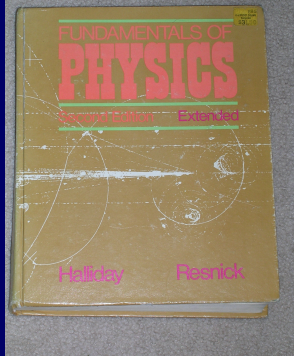

David Halliday died April 2, 2010 in Maple Falls, Washington at the age of 94.

An Emeritus member of AAPT, David was best known to the physics community because of his undergraduate textbook, "Fundamentals of Physics." This textbook has been in continuous use since 1960 and is available in twenty languages. Halliday spent the bulk of his career at the University of Pittsburgh where he was both student and professor, not to mention researcher and administrator. At the time of his death Halliday was still associated with the University of Pittsburgh as a professor emeritus, although he was retired and living in Seattle. —AAPT

This presentation is dedicated to David Halliday, author of my freshman physics text.

Outline

1. Optics
2. Telescopes
3. Total solar irradiance
4. Solar spectrum
5. Spectrographs
6. Observing from Space

Too much, really! I'll go fast, but please ask questions.

Geometrical Optics

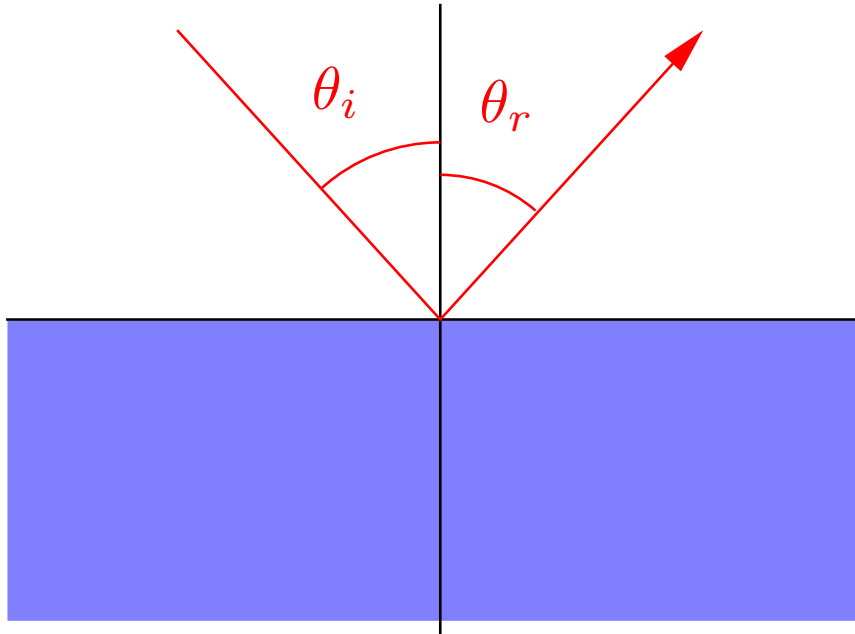

Reflection: $\theta_i = \theta_r$

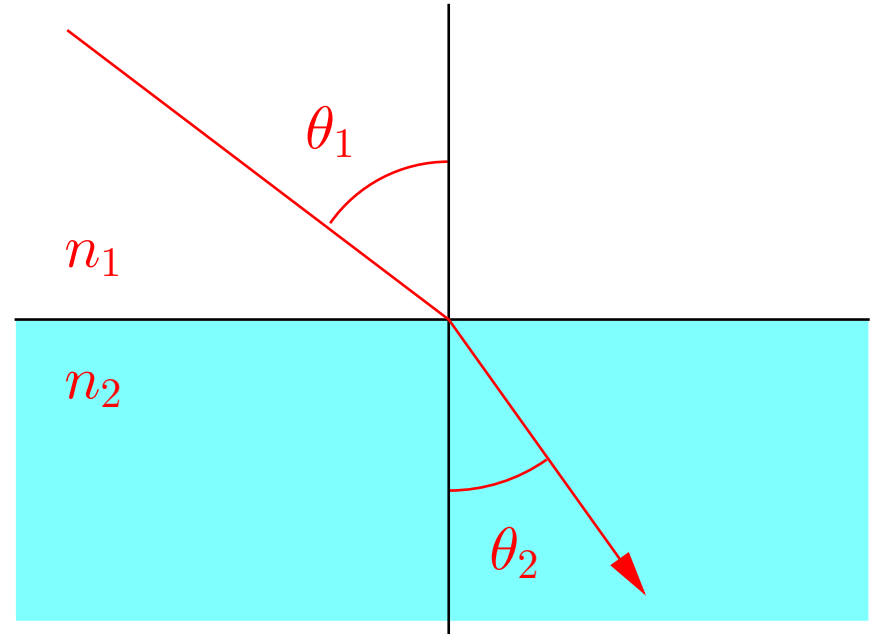

Refraction: $n_1 \sin \theta_1 = n_2 \sin \theta_2$

Conic Sections

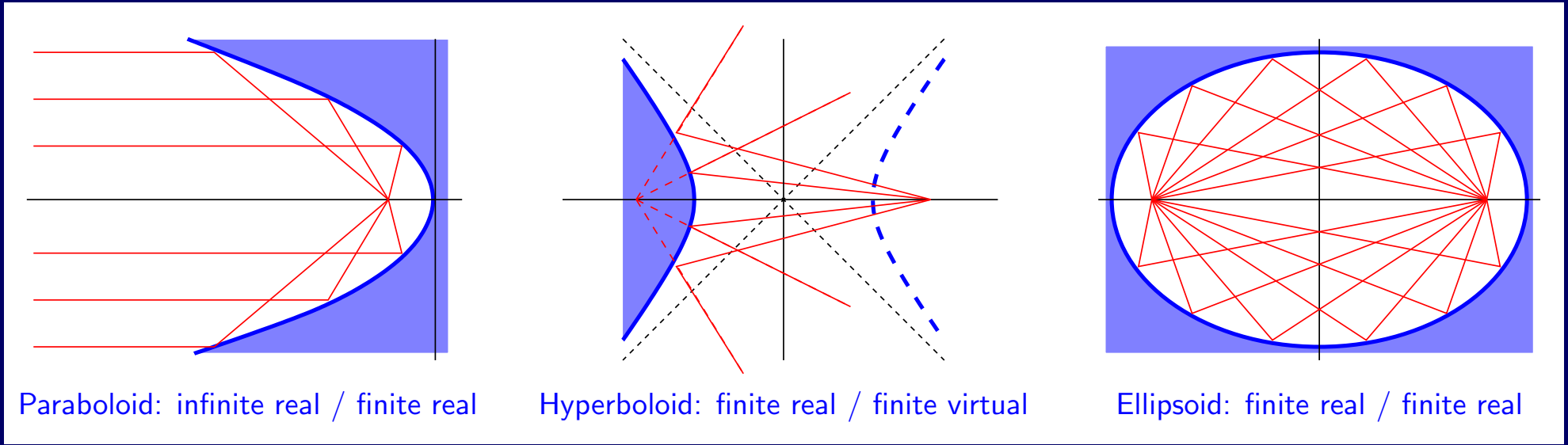

Each of the conic sections has focusing properties that are useful for imaging. In the limit of small aperture, each of these surfaces can be approximated by a sphere.

Thin Lens Approximation

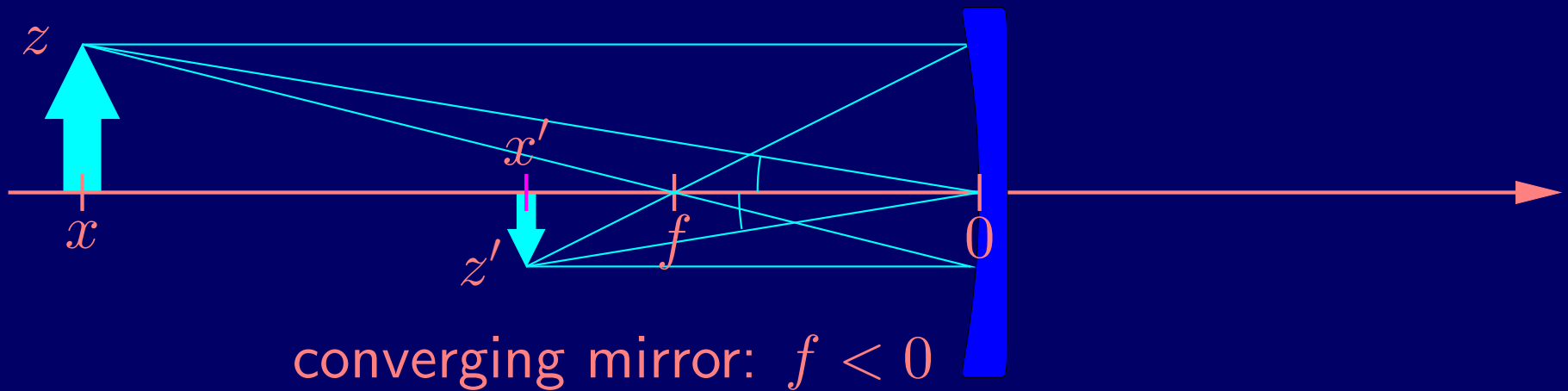
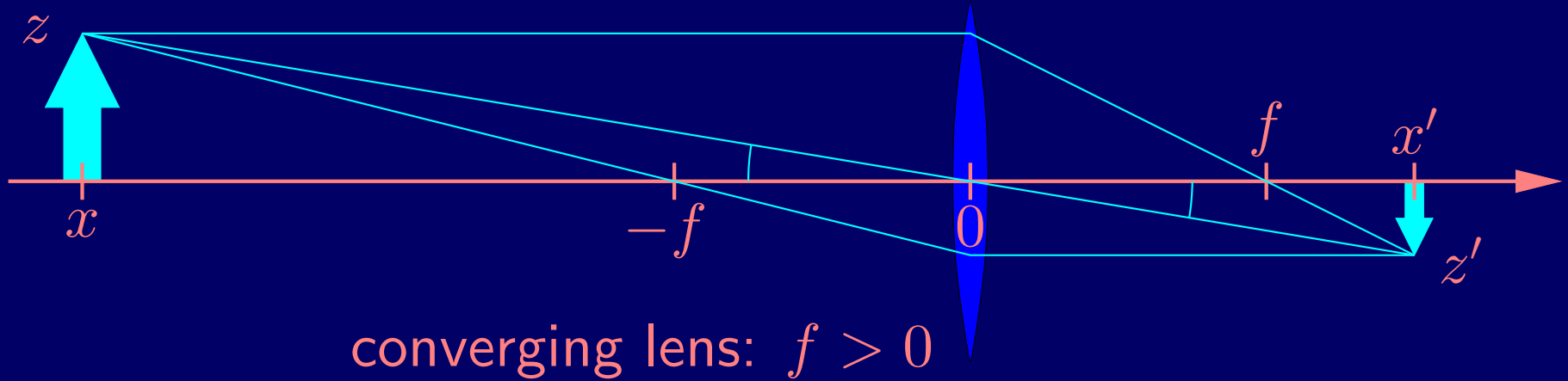

$$\frac{1}{x} + \frac{1}{x'} = \frac{1}{f}; \quad \frac{z}{x} = \frac{z'}{x'}$$

Telescope

A telescope is an imaging instrument in which the distance to the object is much greater than the focal length.

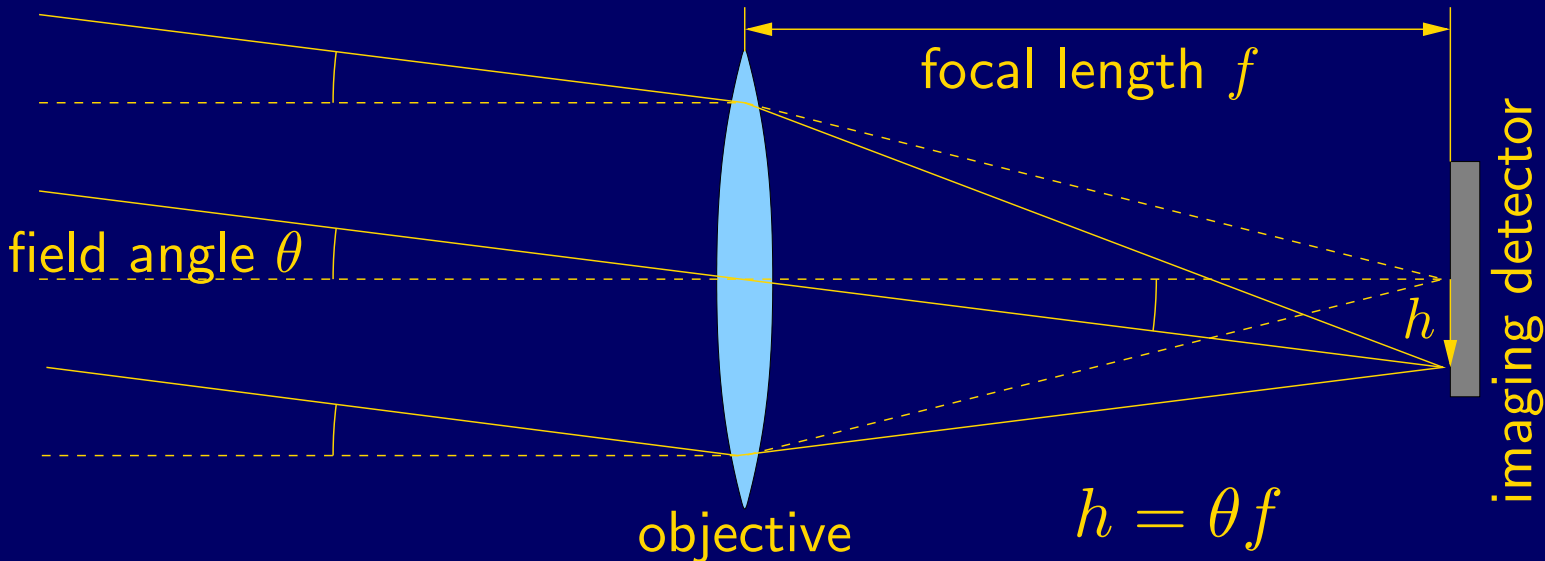

Given perfect optics and plenty of photons, the angular resolution is limited by diffraction: $\Delta\theta = 1.22\frac{\lambda}{D}$.

- Chinese astronomers observed sunspots ca. 400 B.C.

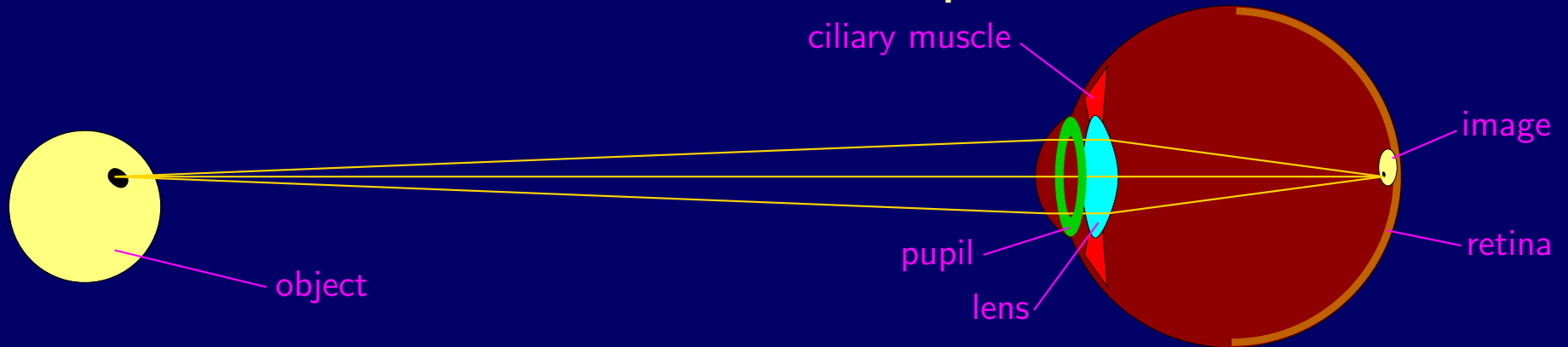

- Never view the Sun without adequate protection!
- Ciliary muscle focuses the eye.
- Pupil adjustment range is typically 2-8 mm.
- Diffraction limit 1.1-0.3 arc minutes (540 nm).
- Eye resolution is about 1 arc minute in daylight.
- Does resolution improve as the pupil opens?

Types of Telescopes

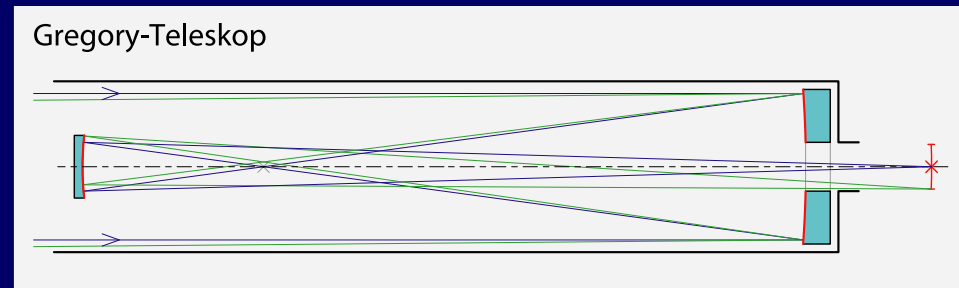
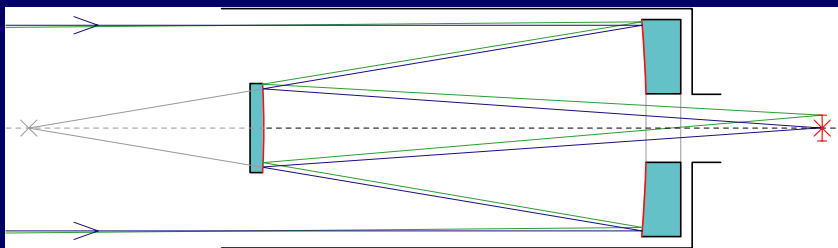
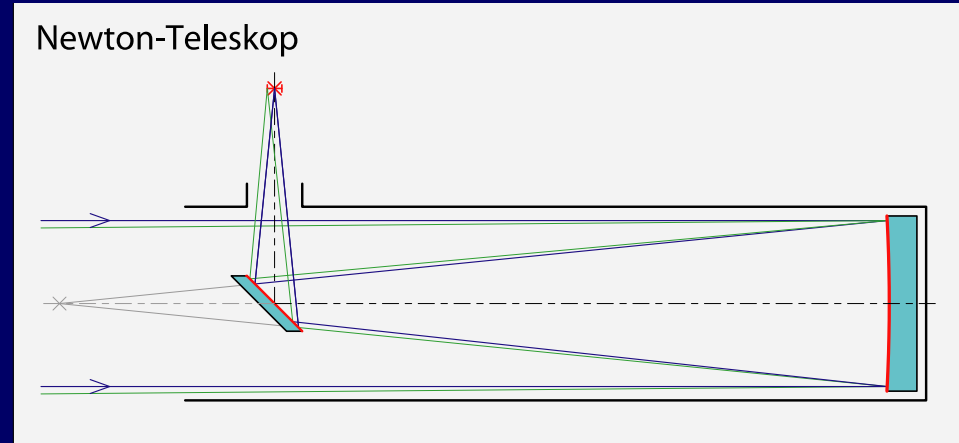
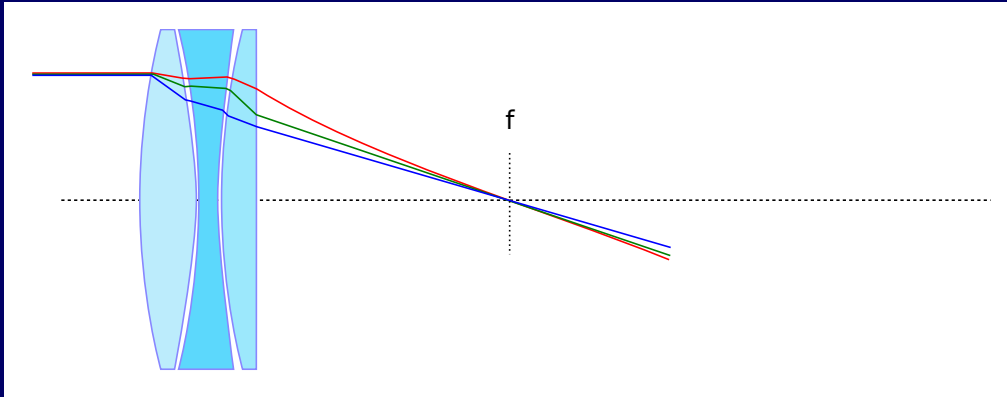

Apochromatic refractor, Newtonian, Cassegrain, and Gregorian.

Capturing Images

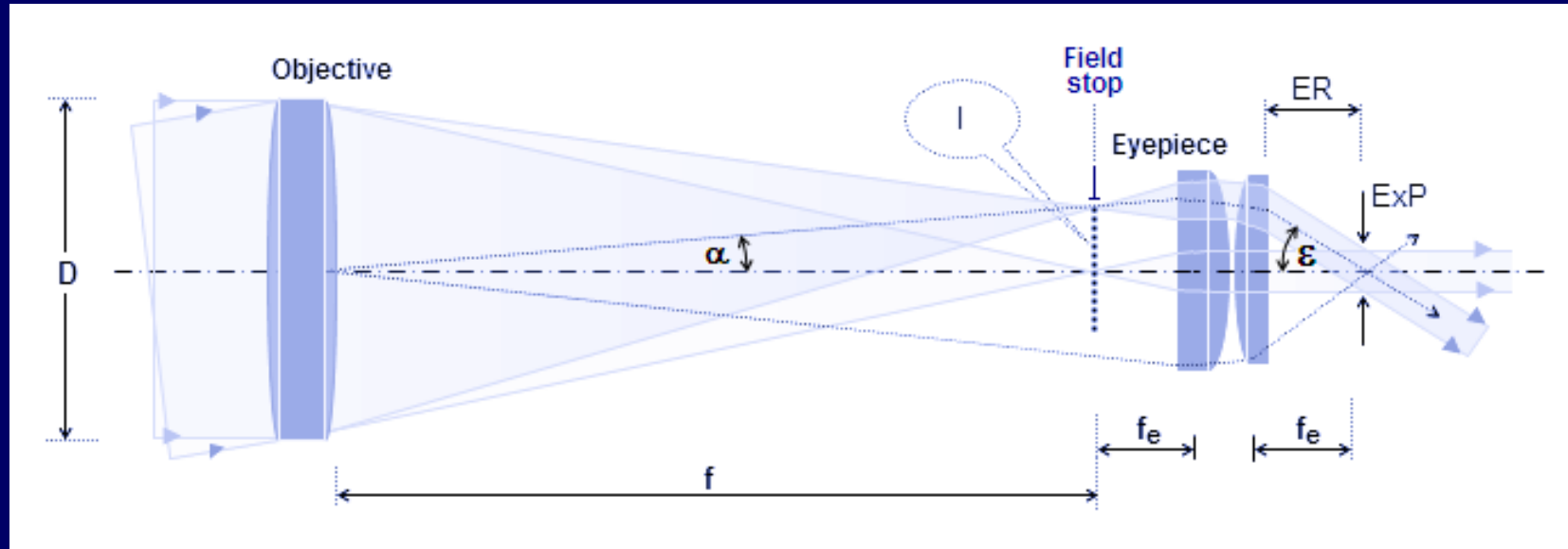

An eyepiece presents a magnified image to your eye.

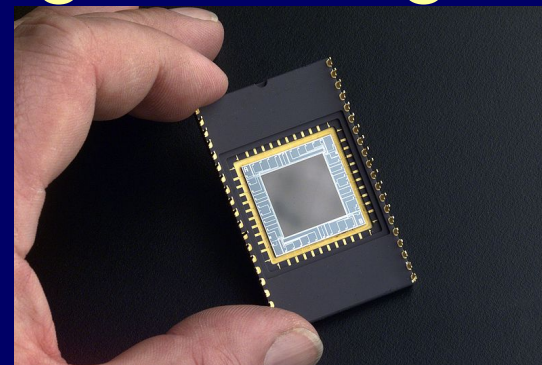
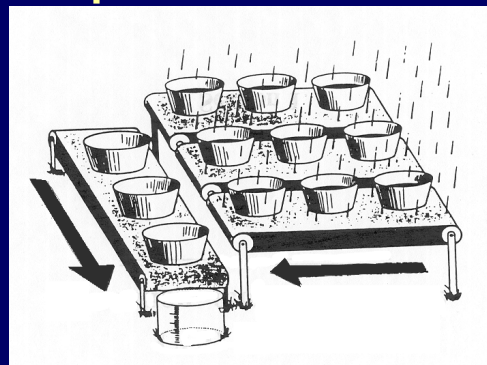

A pixellated sensor, e.g. a CCD, provides digital images.

Kirkpatrick-Baez (right)
and Wolter (below)
X-ray telescopes.

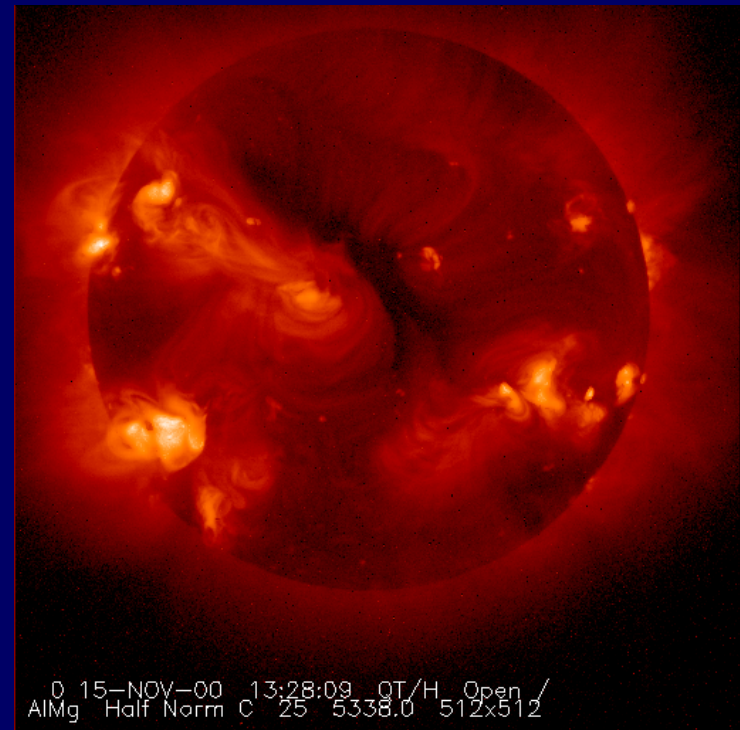
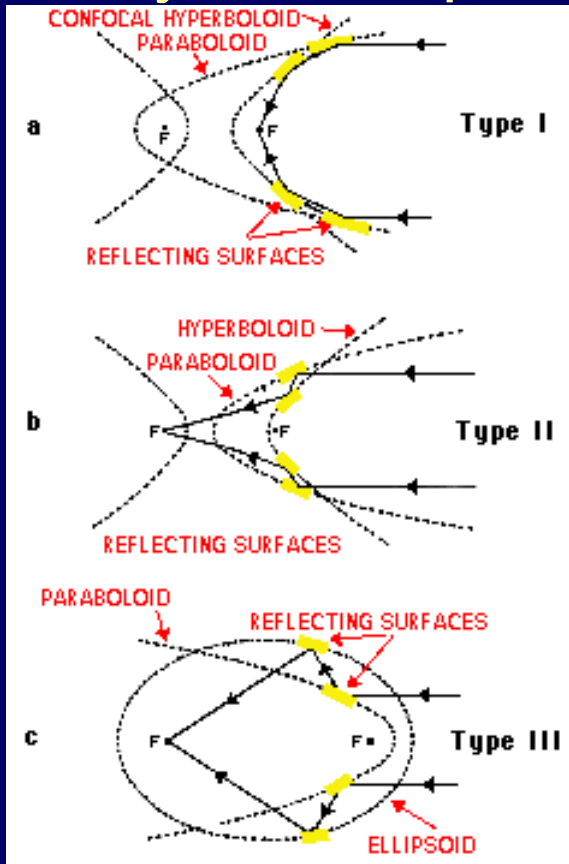
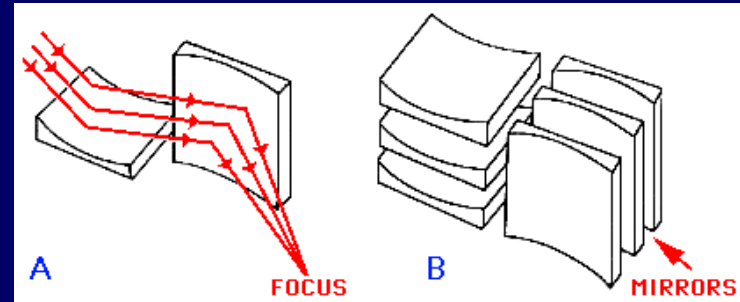

Yohkoh SXT is a Wolter Type I.

Superposition of partial reflections from alternating layers:

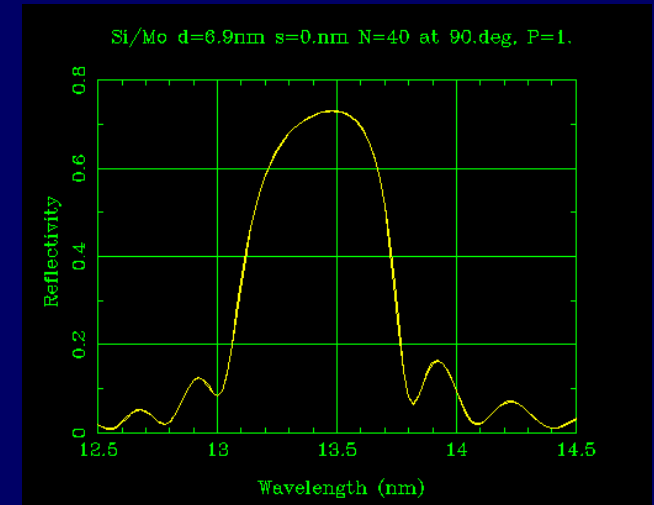
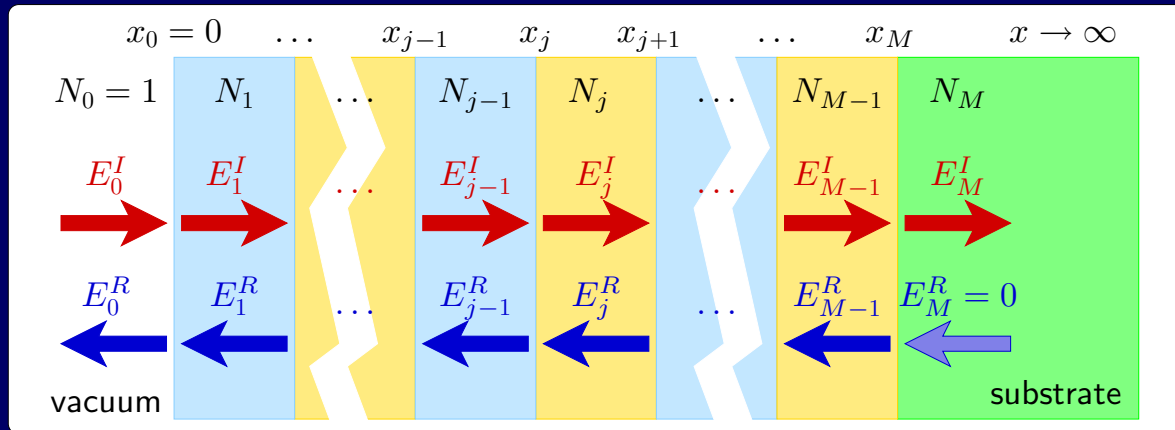

- high reflectivity at normal incidence
- less aberration
- greater aperture
- narrow passband — select lines of interest

Total Solar Irradiance

An Active Cavity Radiometer is a close approximation to a black body. Its temperature is directly related to the total power of radiation at all wavelengths entering the aperture.

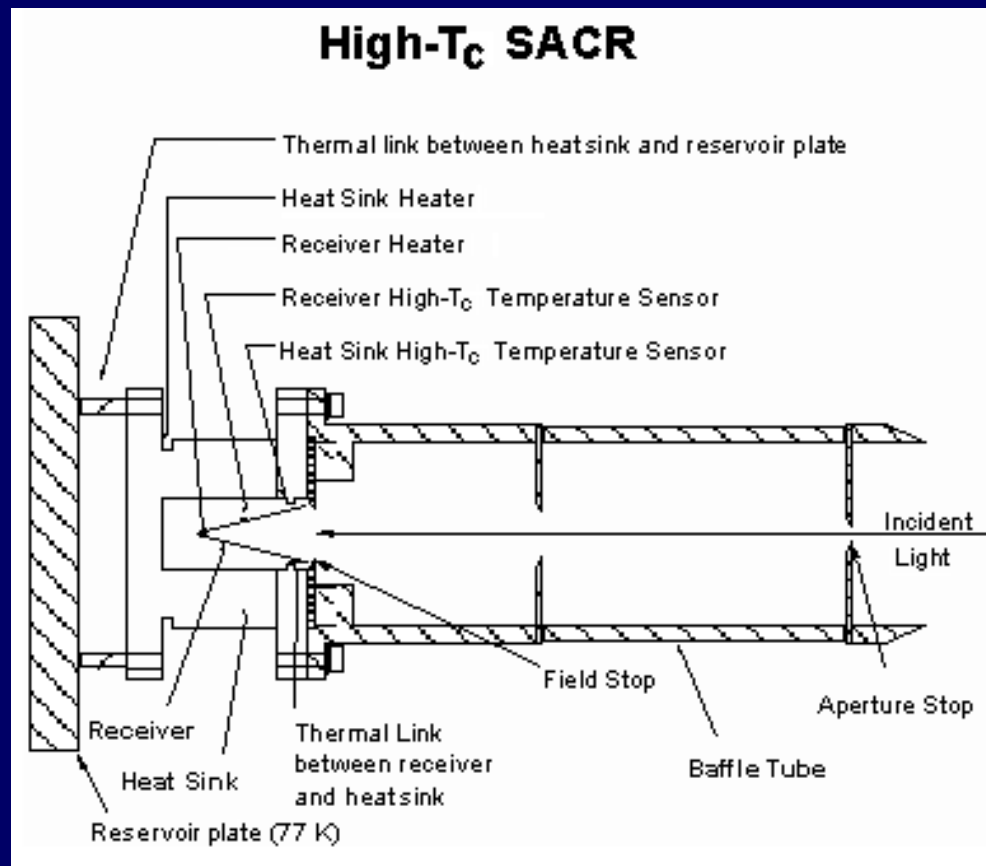

Total Solar Irradiance (1 AU)

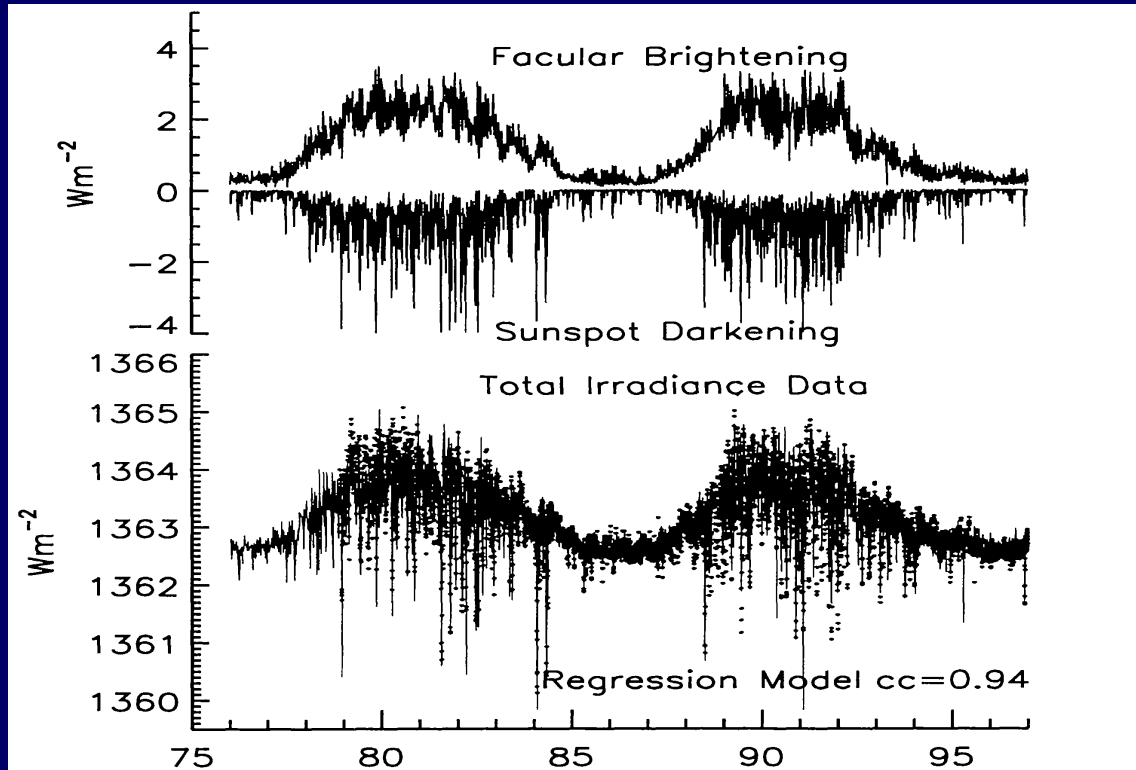

Figure 7. Estimates of the facular brightening and sunspot darkening components of total irradiance variability are compared in the upper panel during two 11-year cycles. When combined, as shown in the lower panel (solid line), these two competing influences together account for 88% of the variance in the composite solar total irradiance record, shown by the symbols.

The Sun varies with an 11-year period
 (Lean & Frohlich 1998).

Solar Spectrum

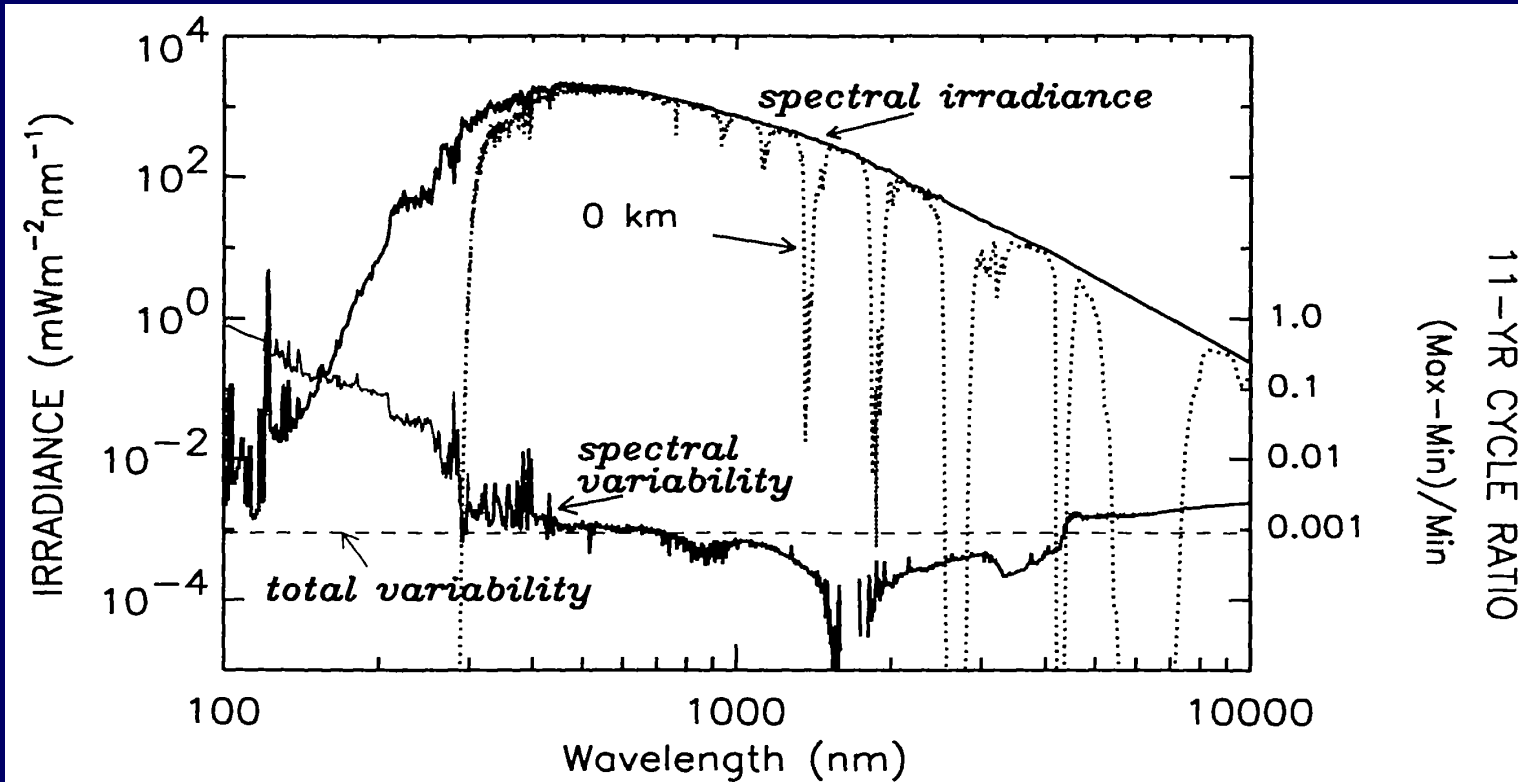
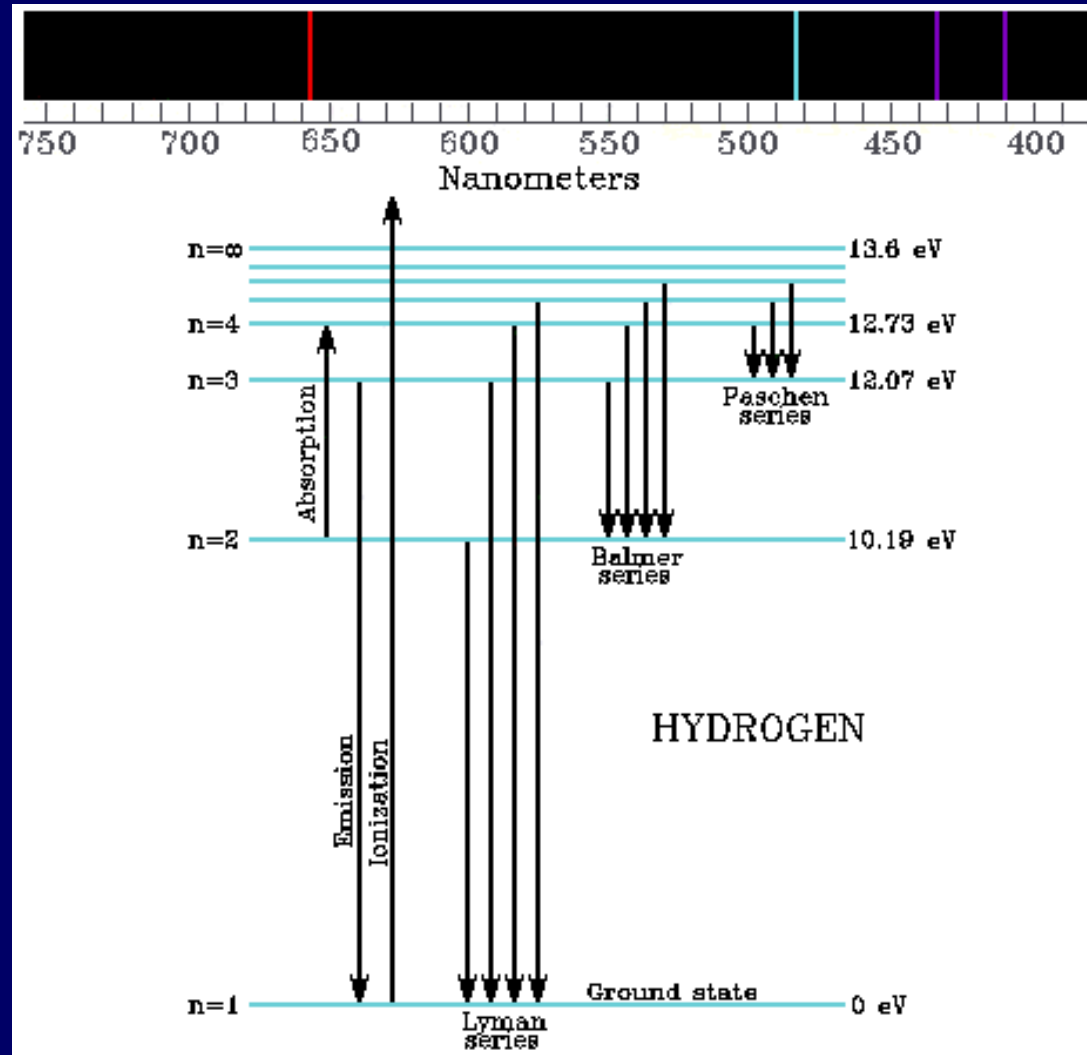

Figure 1. Shown is the spectrum of solar irradiance incident at the top of the Earth's atmosphere and at the surface (0 km). Also shown is an estimate of solar spectrum variability during the 11-year activity cycle compared with that of total irradiance (dashed line).

Which wavelengths can't be observed from the ground?
 (Lean & Frohlich 1998).

Emission and Absorption



When an atom changes states, where does the energy and momentum go?

Energy levels of the hydrogen atom:

$$E_n = \frac{2\pi^2 m e^4}{h^2 n^2} = -\frac{13.6 \text{ eV}}{n^2}.$$

Relationship between wavelength and energy:

$$\Delta E = \frac{hc}{\lambda} = \frac{1240 \text{ eV nm}}{\lambda}.$$

Exercises:

1. Find the wavelength of the $n = 2$ to $n = 1$ transition (Lyman α).
2. Find the wavelength of the $n = 3$ to $n = 2$ transition (Balmer α).
3. Find the wavelength corresponding to ionization from the ground state.

SXR/EUV/FUV Spectrum

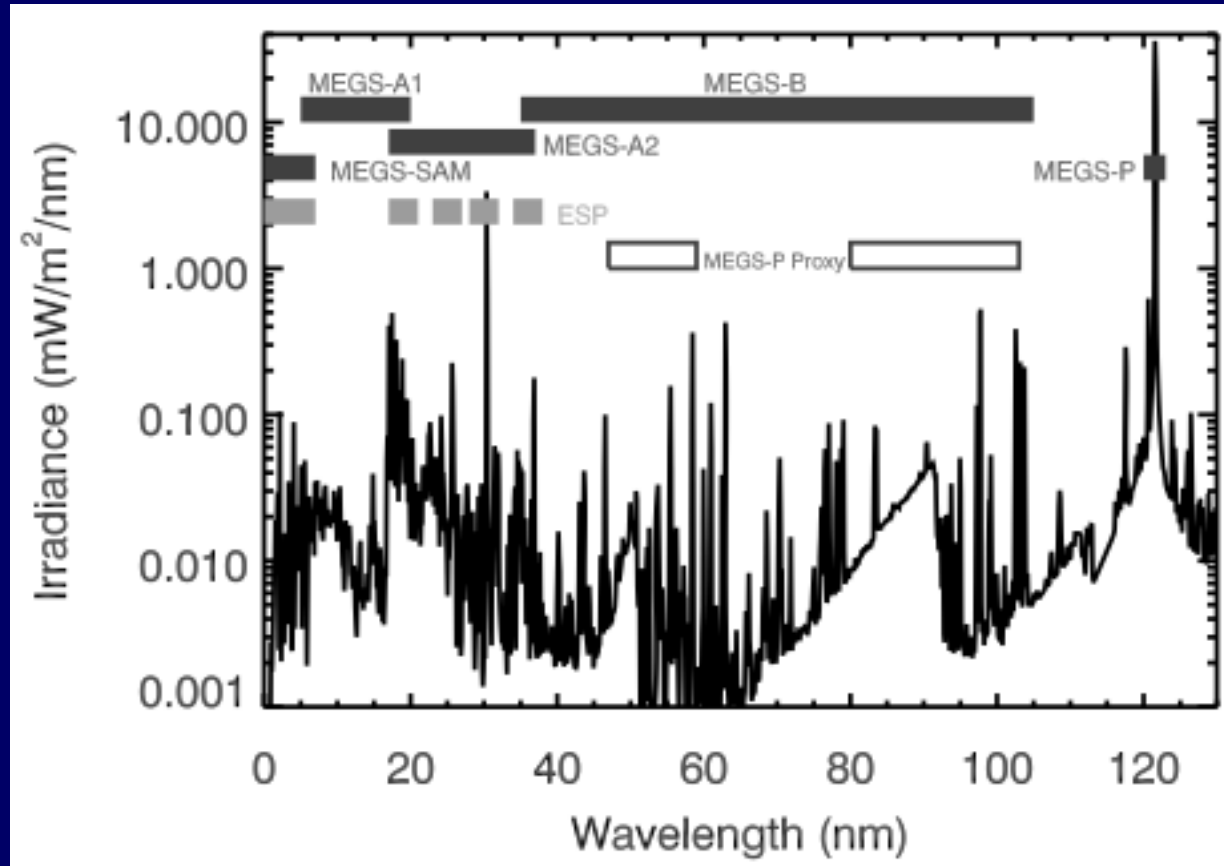

Emission lines and Lyman continuum (Woods et al. 2010).

Can you identify the strong line at 30.4 nm?

SXR/EUV Emission Lines

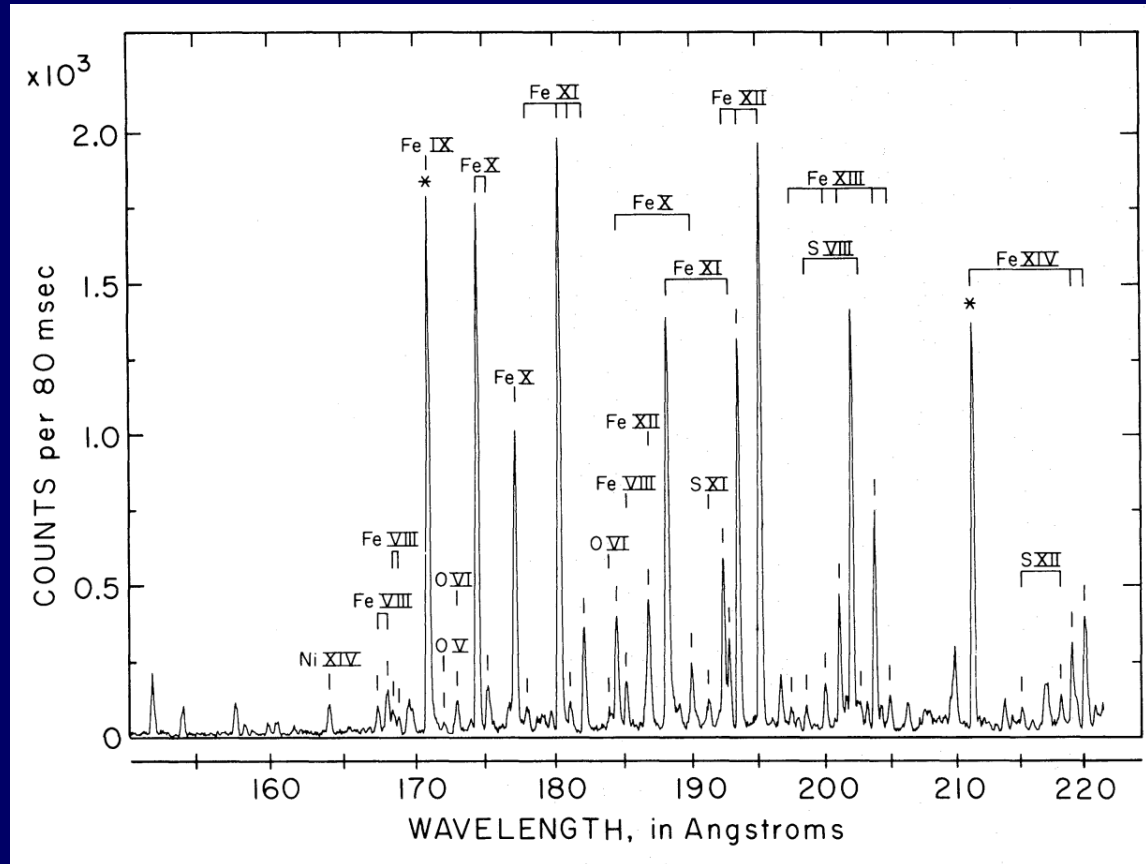

Highly ionized species! Something interesting here!
(Malinovsky & Heroux. 1973).

Diffraction Gratings

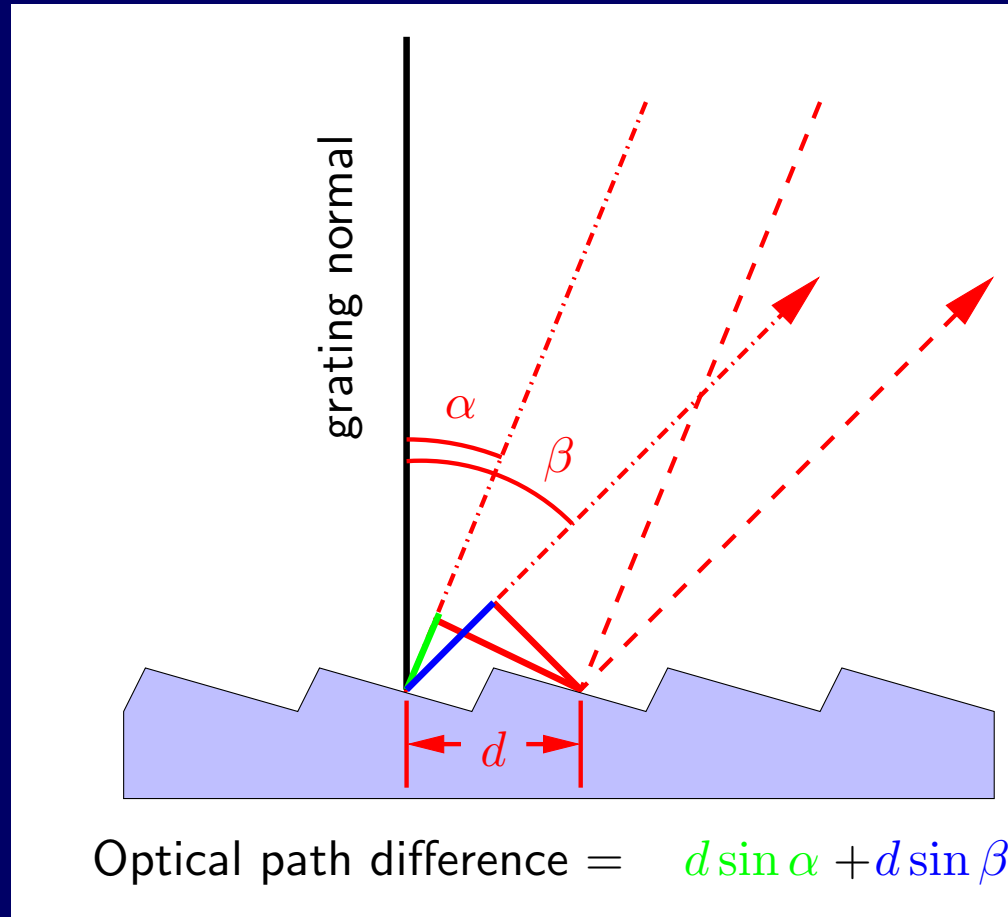

$$d(\sin \alpha + \sin \beta) = m\lambda.$$

A great reference on gratings and spectrographs is the Diffraction Grating Handbook.

Spectrograph (Czerny-Turner)

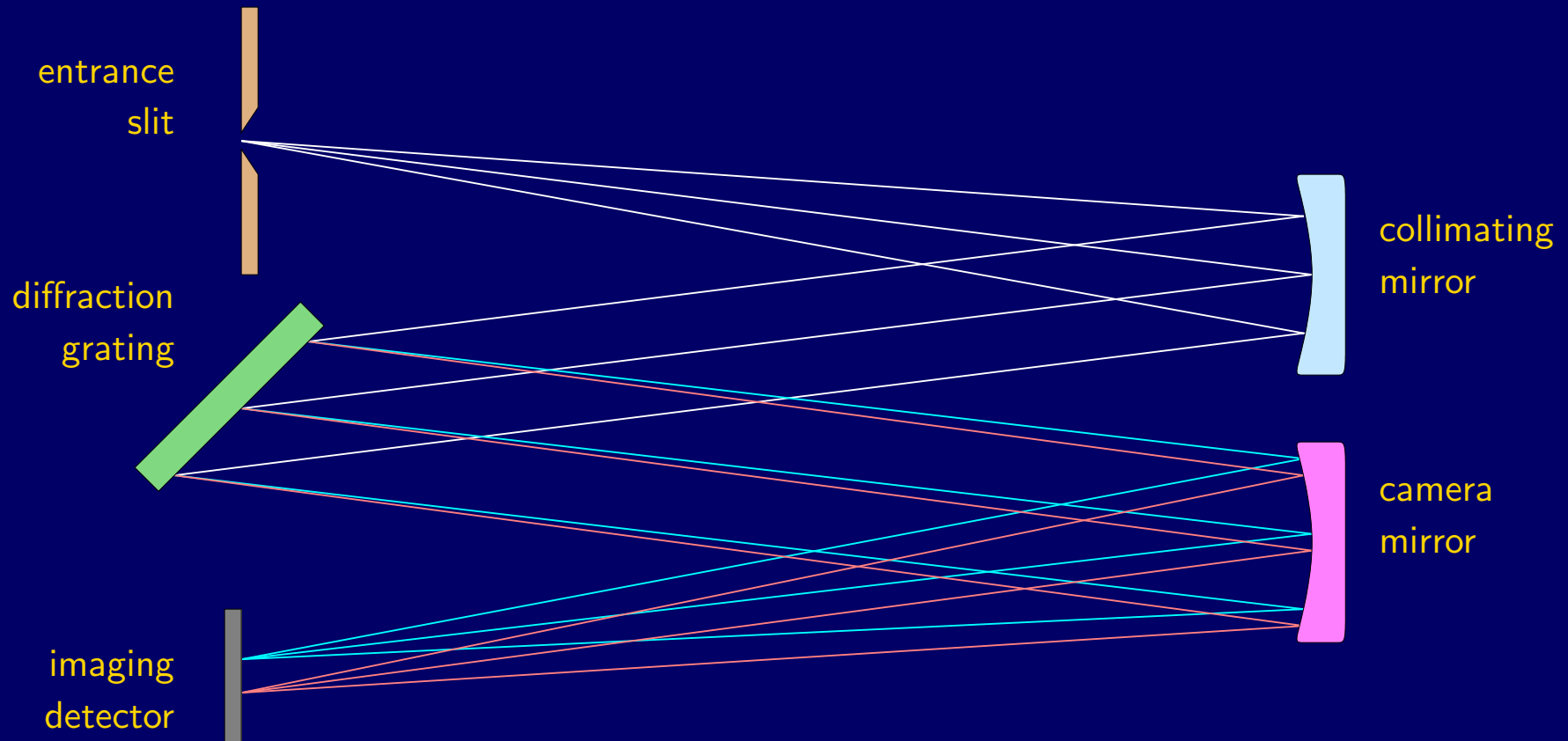

Diffraction limit: if N rulings illuminated by a circular beam,

$$\Delta\lambda = 1.22 \frac{\lambda}{N}$$

Doppler Shift:

$$\Delta\lambda = \lambda \frac{v}{c}$$

Thermal Width:

$$\sigma = \lambda \frac{v_{th}}{c} = \lambda \sqrt{\frac{k_B T}{mc^2}}$$

What spectral resolution, $N \sim \lambda/\Delta\lambda$, is required to resolve the thermal width of H Lyman α radiation emitted from the chromosphere ($\sim 4 \times 10^4$ K)?

Imaging Spectrograph

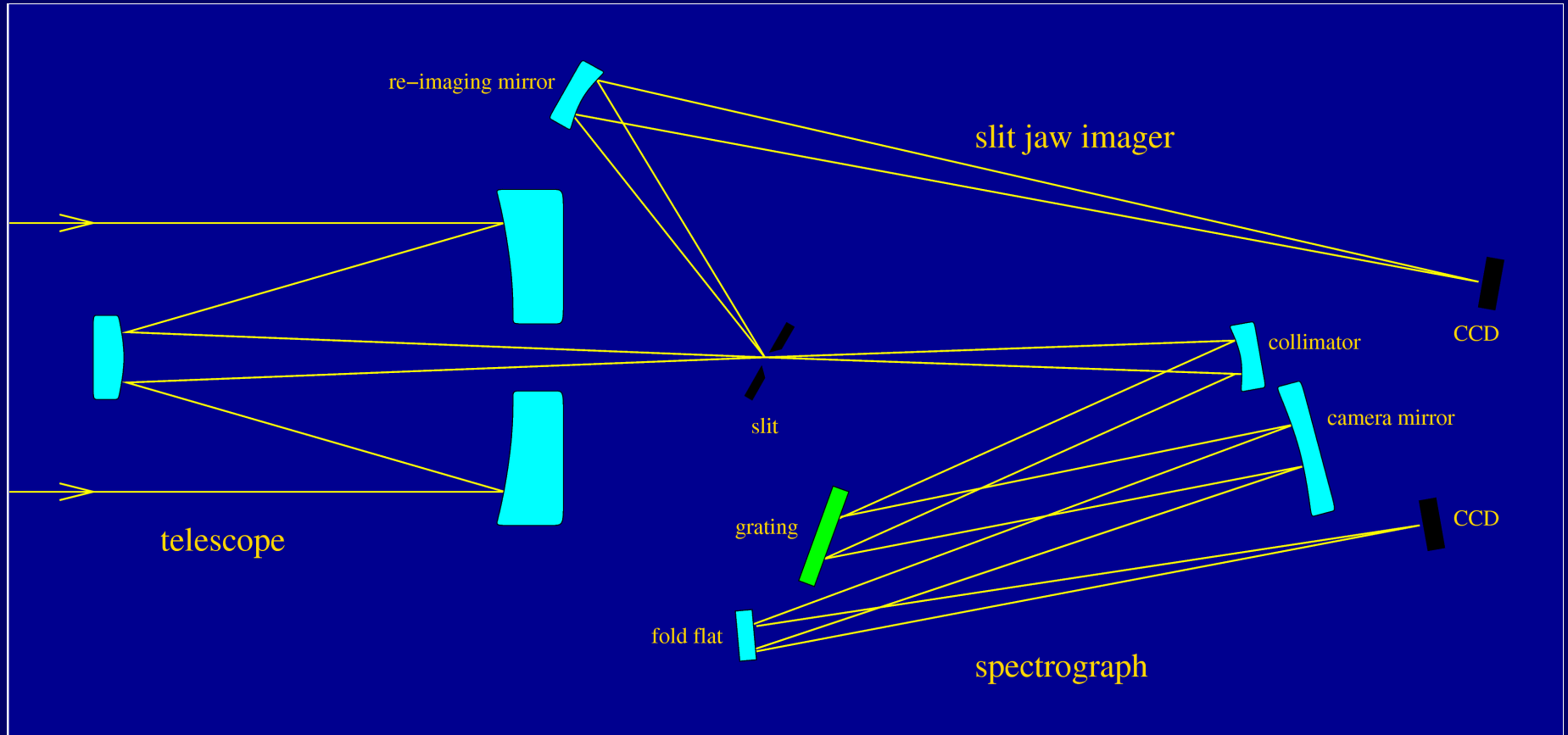

Sketch of the IRIS UV imaging spectrograph. Optics for the spectrograph and slit jaw imager are being specified, procured and tested at MSU.

Effects of Earth's atmosphere:

- blurring and distortion
- cloud cover
- absorbs $\lambda < 200$ nm



Montana from 100,000 ft.

Solution: Wernher Von Braun!

Mission Design

Where in space should we go to observe?

- Suborbital (*MOSES*)
- Low Earth orbit (*Yohkoh*)
- Sun synchronous orbit (*TRACE*)
- Geosynchronous orbit (*SDO*)
- Lagrange points (*SOHO*)
- Beyond Earth's gravity well (*STEREO*)

Suborbital Rockets

MSU's *Multi-Order Solar EUV Spectrograph (MOSES)*

- First flight Feb 2006
- Max altitude: 260 km
- Duration: 5 min above 160 km
- Low cost—test new ideas
- Recover, refit, refly



Newton's second law: $a = F/m$.

Centripetal acceleration in a circular orbit:

$$a_C = g \left(\frac{R_E}{R} \right)^2 = \frac{v^2}{R} = R\omega^2 = \frac{4\pi^2 R}{T^2}.$$

A satellite in LEO has a period of 90 minutes. Use this to estimate the radius of the Earth.

$$T^2 \propto R^3.$$

Find R/R_E if $T = 24$ hr (geosynchronous).

Yohkoh (LEO)

- Low Earth Orbit (LEO)
- Duration: 1991-2001
- Elliptical orbit, 530×730 km AGL
- Orbital period 90 min
- Spacecraft day/night cycles

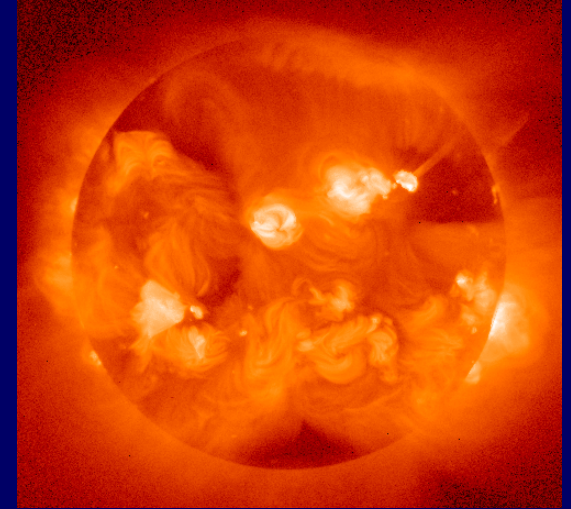

Yohkoh Soft X-Ray
Telescope image of
the solar corona.

Transition Region and Coronal Explorer (TRACE)

- April, 1998 - present
- Orbit 600×650 km AGL
- Follows terminator
- Sun visible 24×7
- But: eclipse seasons

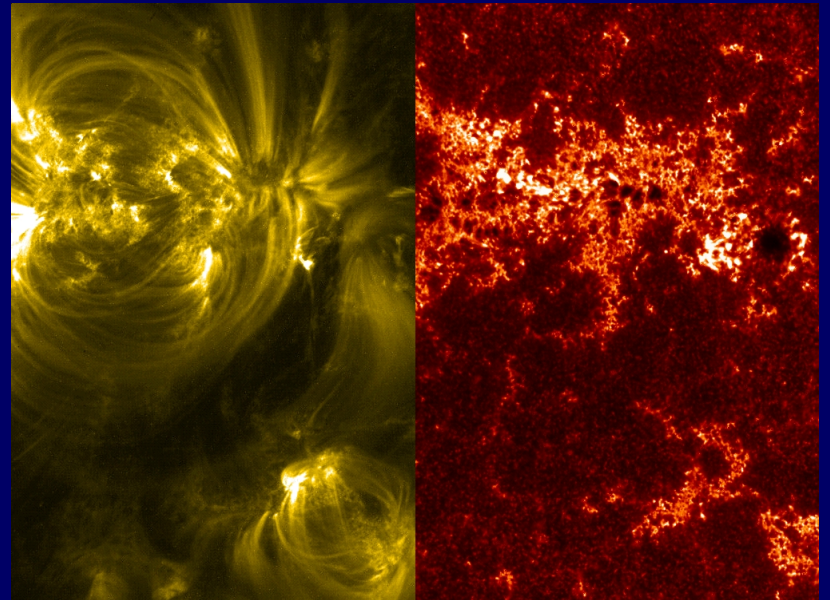

How it works: Earth's oblateness causes precession of the orbit. Precession rate depends on both altitude and the inclination. Tune for 2π radians/year.

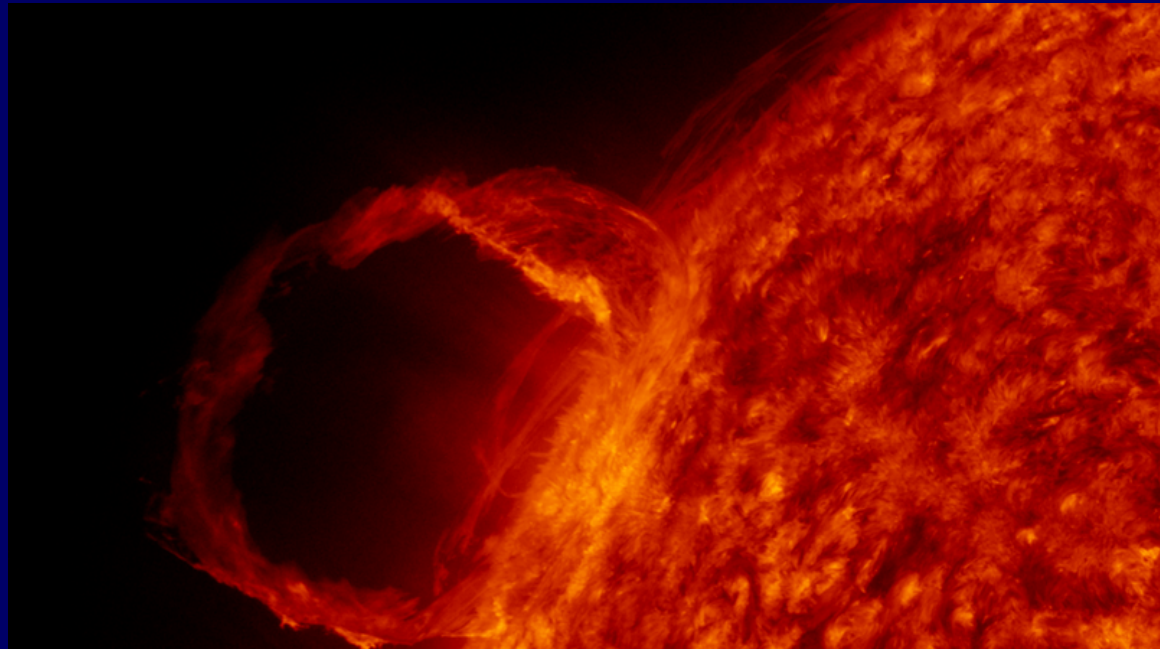
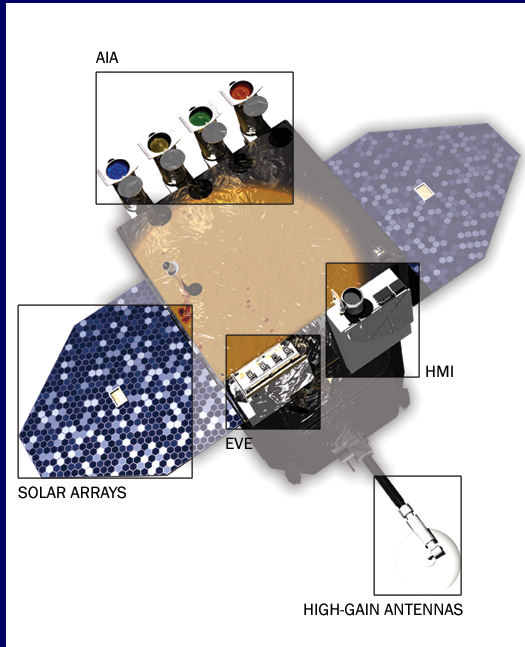

Solar Dynamics Observatory

- Rarely eclipsed (why?)
- Always visible from a single ground station
- Massive telemetry bandwidth (1.5 TB/day)

SOHO: L1 halo orbit

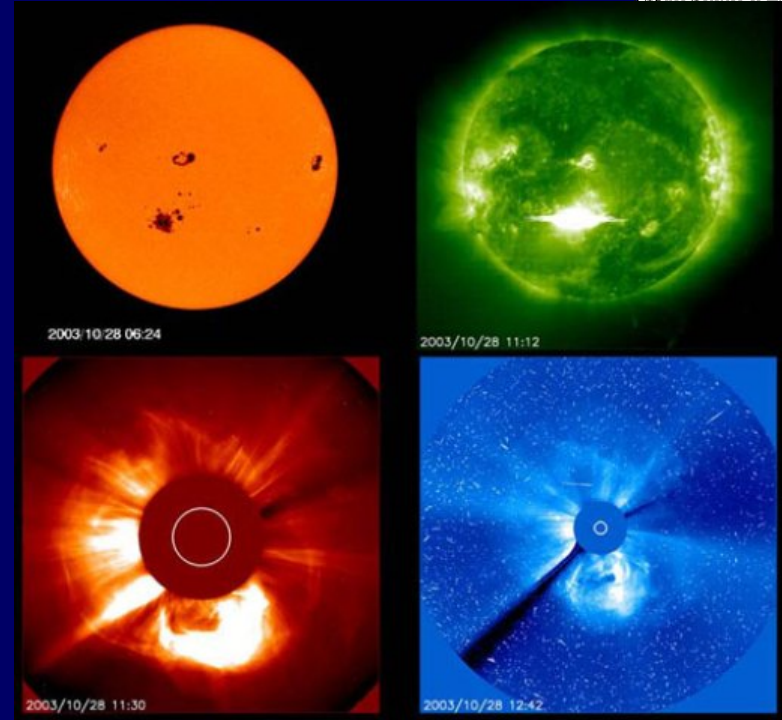
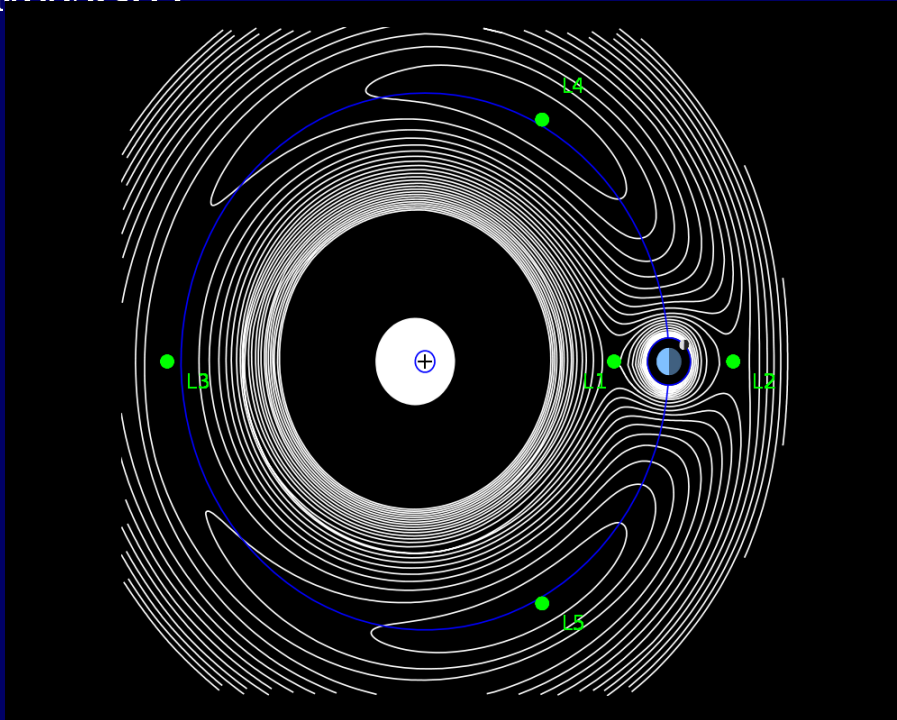

- 1995-present. Sees the Sun 24×7
- Immersed in the solar wind beyond the influence of Earth's magnetic field
- 1.5 million km (0.01 AU) sunward of Earth
- Telemetry via Deep Space Network (expensive, slow)

Stereoscopic perspective allows “depth perception” for objects in the solar corona and heliosphere.

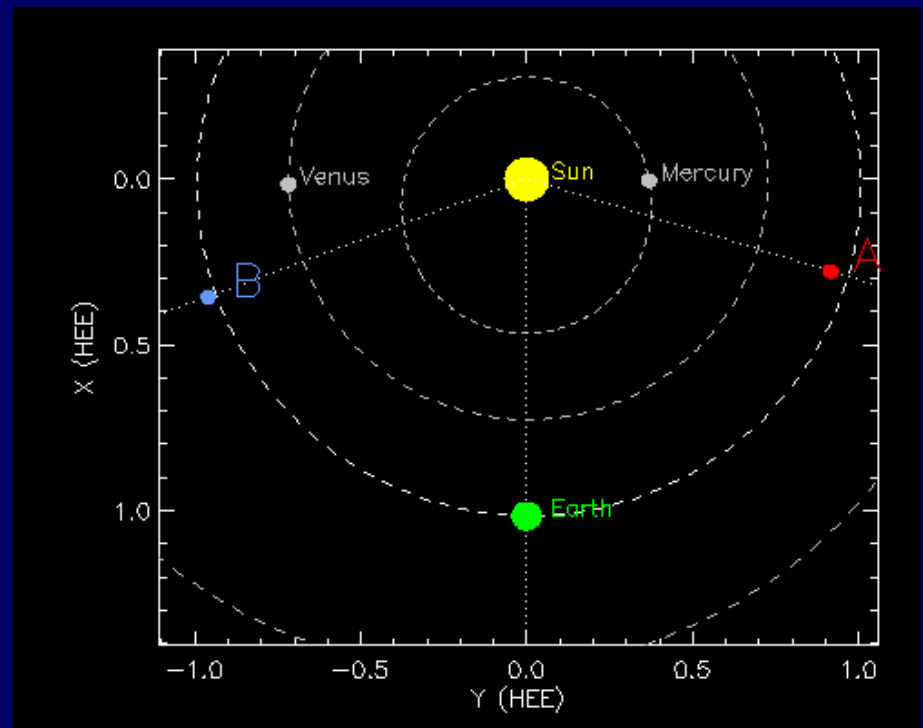
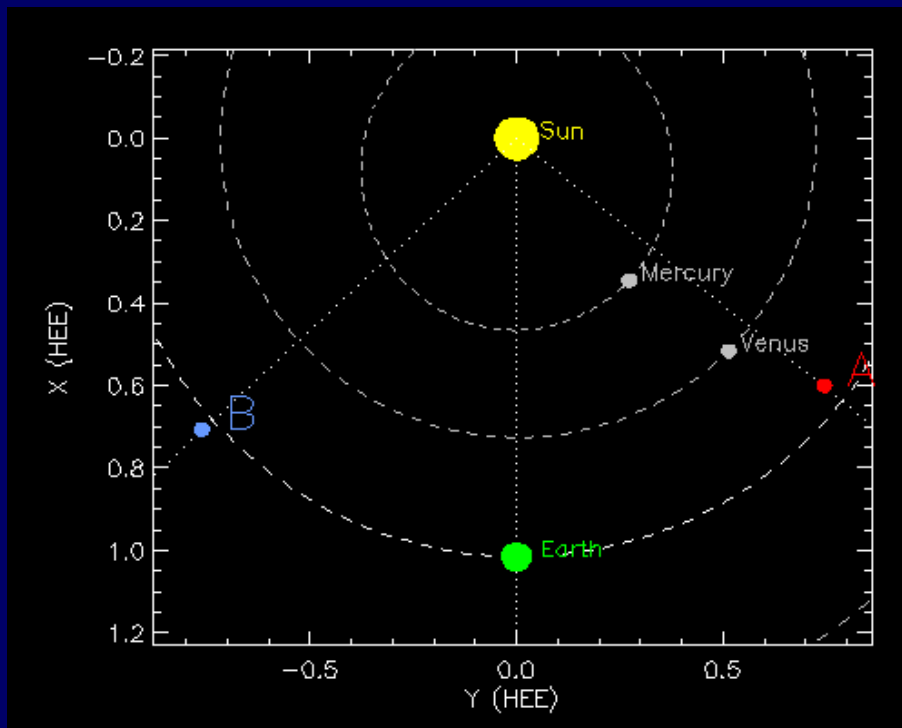

The twin *STEREO* spacecraft on June 9, 2009 and 2010 respectively. How does the orbit work?

Conclusion

This has been a selective, superficial look at solar observations, yet each slide could fill a semester. Among the things we have left unconsidered are:

- Coronagraphs
- Filtergraphs, polarimetry and magnetography
- Radiotelescopes
- *In situ* measurement of solar wind plasma
- practical instrument development: sensitivity analysis, electronics, contamination, thermal, command & data handling